



KLETON builds quality and dependability into all of their products!

Do you have a custom application?

Not a problem! KLETON specializes in custom requests. Look for the “K” custom logo throughout this catalogue. Don’t see what you’re looking for? Simply contact one of our sales representatives and we’ll be pleased to help you out.

CUSTOMIZE . . .

- Strip Curtain Doors
- Platform Trucks
- Safety Guards
- Bollards
- Gas Cylinder Cabinets
- Workbenches
- Shelf Trucks
- And more...

Contact us today!



Built **KLETON**
Tough for 40 years!

QUICK INDEX

MATERIAL HANDLING EQUIPMENT

3-63

SHOP & INDUSTRIAL FURNITURE

64-88

LADDERS, STANDS & PLATFORMS

89-94

WAREHOUSE AND STORAGE

95-138

DRUM HANDLING EQUIPEMENT

139-143

DRUM PUMP AND ACCESSORIES

144-152

PACKAGING

153-167



MATERIAL HANDLING EQUIPMENT

Hydraulic Scissor Lift Tables	4 - 5	Shelf Trucks	33 - 35
Heavy Duty Hydraulic Scissor Lift Tables	6 - 7	Low Profile Shelf Trucks	36
Hydraulic Pallet Trucks	8 - 11	Stock Picking Trucks	37
Pallet Handling Equipment	12	Order Picking Trucks	37
Fork Extensions	12	Mobile Service Carts	38 - 41
Quick Links & Snap Hooks	13	Ergonomic Shelf Trucks	39
Hydraulic Platform Lift Stacker	13	Plastic Shelf Trucks	40
Pallet Pullers	13	Mail & Utility Carts	41
Spring Operated Pallet Lifter	14	Platform Trucks	42 - 50
Pallet Lifters	14	Platform Wagon Trucks	46
Hoists	15 - 17	Elevated Platform Trucks	46
Trolleys	17	Skids	47
Hand Trucks	18 - 25	Foldable Platform Trucks	48
Gas Cylinder Carts	21	Aluminum Platform Trucks	49 - 50
Aluminum Hand Trucks	22 - 24	Dollies	51 - 53
Specialized Hand Trucks	25	Specialized Carts	54 - 57
Tilt Trucks	26	Workhorses	56
Box Trucks	27 - 30	Casters	58 - 61
Self Dumping Hoppers	27	Wheel Chocks	62 - 63
Stock Trucks	29 - 31	Trailer Stabilizing Jack	63
Security Trucks	32		

HYDRAULIC SCISSOR LIFT TABLES

Kleton tables are available in various capacities and travels to satisfy a wide variety of applications. All tables have an integrated hydraulic pump/cylinder assembly. Kleton scissor lift tables add the value of mobility to the hydraulic lift table concept. Exceptional functionality and manoeuvrability is apparent, whether loaded or empty. In addition, rugged construction and premium-quality hydraulics complement their ease of use with low maintenance.

APPLICATIONS

Kleton tables are used in a wide variety of applications, from stocking shelves to lifting and moving materials in warehouses, machine shops and manufacturing operations.

FEATURES:

- Ergonomic push handle with easy to use release handle to lower the platform
- Hydraulic foot pump raises the platform

OPERATION

The Kleton design allows workers to easily move and position loads to a convenient working height. By minimizing undesirable lifting, reaching and stretching, Kleton tables increase productivity and decrease workplace injuries.

- Quality orange powder coated finish provides exceptional durability and corrosion resistance
- (2) Rigid 5" polyurethane casters
- (2) Swivel 5" polyurethane casters with brake



Model No.	Platform Dimensions	Capacity lbs	Raised Height"	Lowered Height"	Total Pedal Strokes
MP005	27-1/2" x 17-3/4"	330	29.13	8.85	25



Model No.	Platform Dimensions	Capacity lbs	Raised Height"	Lowered Height"	Total Pedal Strokes
MP006	32" x 19-3/4"	660	35.4	11	36



Model No.	Platform Dimensions	Capacity lbs	Raised Height"	Lowered Height"	Total Pedal Strokes
MP007	35-3/4" x 19-3/4"	770	51.1	13.7	60



Model No.	Platform Dimensions	Capacity lbs	Raised Height"	Lowered Height"	Total Pedal Strokes
MP008	32" x 19-3/4"	1100	35.4	11	45

HYDRAULIC SCISSOR LIFT TABLES

FEATURES:

- Ergonomic push handle with easy to use release handle to lower the platform
- Hydraulic foot pump raises the platform

- Quality powder coated finish provides exceptional durability and corrosion resistance
- (2) Rigid 5" polyurethane casters
- (2) Swivel 5" polyurethane casters with brake



Model No.	Platform Dimensions	Capacity lbs	Raised Height"	Lowered Height"	Total Pedal Strokes
MP009	63" x 31-1/2"	1100	35.4	12.2	55



Model No.	Platform Dimensions	Capacity lbs	Raised Height"	Lowered Height"	Total Pedal Strokes
MP010	39-1/2" x 20"	1650	39.3	16.5	70



Model No.	Platform Dimensions	Capacity lbs	Raised Height"	Lowered Height"	Total Pedal Strokes
MP011	40" x 20"	2200	39.3	14.9	55



Model No.	Platform Dimensions	Capacity lbs	Raised Height"	Lowered Height"	Total Pedal Strokes
MP012	48" x 24"	1540	59	18.7	70

HEAVY-DUTY HYDRAULIC SCISSOR LIFT TABLES

FEATURES

- Heavy-duty construction with captured scissor rollers for maximum stability
- High-quality casters and wheels for exceptional roll ability (two fixed, two swivel)
- Superior hydraulic systems feature an integrated pump-cylinder for maximum reliability
- Ergonomic push handle with convenient lowering control
- Lowering control automatically stops when released for added safety
- Convenient maintenance pins secure the scissor legs for inspection and maintenance on Model **MJ525**
- Quality powder-coat finish provides exceptional durability and corrosion resistance
- Colour: Kleton Blue
- Features heavy-duty steel release handle

APPLICATIONS

Kleton tables are used in a wide variety of applications, from stocking shelves to lifting and moving materials in warehouses, machine shops and manufacturing operations.

OPERATION

The Kleton design allows workers to easily move and position loads to a convenient working height. By minimizing undesirable lifting, reaching and stretching, Kleton tables increase productivity and decrease workplace injuries.



MJ518 Collapsible Handle

 **FIND OUT HOW IT WORKS**
www.Youtube.com/KletonInd



MJ519 & MJ521 Collapsible Handle



MJ519



MJ520

Model No.	Load Cap lbs.	Platform Height Lowered"	Platform Height Raised"	Platform Size Width"	Platform Size Length"	Handle Height"	Pedal Strokes To Max	Wt. lbs.	Wheel Size
MJ518	330	8-5/8	29	17-3/4	27-1/2	37-3/8	28	95	4"
MJ519	660	11-1/4	34-5/8	19-3/4	32	39	27	151	5"
MJ520	770	14	51-1/4	19-3/4	35-3/4	38-3/8	53	215	5"
MJ521	1100	11-1/4	34-5/8	19-3/4	32	39	27	173	5"

Note: Platform height lowered and raised includes the casters

HEAVY-DUTY HYDRAULIC SCISSOR LIFT TABLES

 FIND OUT HOW IT WORKS
www.Youtube.com/KletonInd

MJ522



MJ523



MJ526



MJ525



MJ524



Model No.	Load Cap lbs.	Platform Height Lowered"	Platform Height Raised"	Platform Size Width"	Platform Size Length"	Handle Height"	Pedal Strokes To Max	Wt. lbs.	Wheel Size
MJ522	1100	11-1/4	36	31-7/8	63	39	55	341	5"
MJ523	1650	16-1/2	35-3/8	20-1/8	39-3/8	39-3/8	45	264	5.75"
MJ524	2200	15	39	20-1/8	40	38-5/8	82	272	5"
MJ525	2200	15	53-1/2	29-1/2	80-1/8	39-3/8	200	682	5"
MJ526	1545	17-1/2	59-1/8	24	48	40	97	430	5"

Note: Platform height lowered and raised includes the casters

HYDRAULIC PALLET TRUCKS

HYDRAULIC PALLET TRUCKS

The 3-function hand control (raise, neutral and lower) and the spring loaded self-righting safety loop handle enhance comfort and ease of operation. Hardened chrome piston with protective dust cover for dependable performance. Durable powder coat finish.

- Heavy-duty polyurethane tread bonded to cast iron core steering wheels and rollers provide superior performance
- Heavy-duty plastic roller facilitates entry and exit of pallets
- 6-1/4" (158.75 mm) wide forks
- Lowered pallet truck height: 3-1/4"
- Raised pallet truck height: 7-3/4"
- Colour: Yellow
- Frame Material: Steel
- 1-year limited warranty

**5500-LB.
CAPACITY**



3-function hand control (raise, neutral and lower) and spring-loaded self-righting safety loop handle.

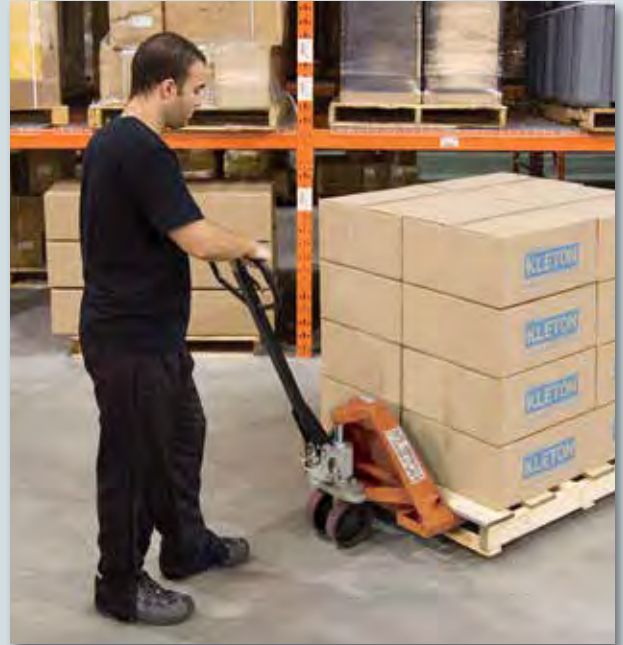

Model No.	Overall Fork Dim.	
	Width"	Length"
ML966	20-1/2	36
ML967	20-1/2	42
ML968	20-1/2	48
ML969	27	36
ML970	27	42
ML971	27	48
ML972*	27	48

*All nylon core steering wheels and rollers

HYDRAULIC PALLET TRUCKS



**5500-LB.
CAPACITY**

HEAVY-DUTY SERIES HYDRAULIC PALLET TRUCKS

- Heavy-duty polyurethane thread bonded to cast iron core and rollers provide superior performance
- 6-1/4" (158.75 mm) wide forks
- Lowered pallet truck height: 2-7/8"
- Raised pallet truck height: 7-3/4"
- Colour: Orange

Model No.	Overall Fork Dim.	
	Width"	Length"
MJ484	20-1/2	36
MJ485	20-1/2	42
MJ486	20-1/2	48
MJ487	27	36
MJ488	27	42
MJ489	27	48
ML372*	27	48

* All nylon core steering wheels and rollers



**6600-LB.
CAPACITY**

HEAVY-DUTY SERIES HYDRAULIC PALLET TRUCKS

- Heavy-duty polyurethane thread bonded to cast iron core and rollers provide superior performance
- Double rollers for easy moving of extra heavy loads
- Reinforced fork channels deliver exceptional durability
- 6-1/4" (158.75 mm) wide forks
- Lowered pallet truck height: 2-7/8"
- Raised pallet truck height: 7-3/4"
- Colour: Kleton blue

Model No.	Overall Fork Dim.	
	Width"	Length"
MJ490	20 1/2	36
MJ491	20 1/2	42
MJ492	20 1/2	48
MJ493	27	36
MJ494	27	42
MJ495	27	48
ML373*	27	48

* All nylon core steering wheels and rollers



**11000-LB.
CAPACITY**

SUPER HEAVY-DUTY HYDRAULIC PALLET TRUCK

- Heavy-duty nylon steering wheels and rollers provide maximum mobility and performance
- Double rollers for easy moving of extra heavy loads
- 2-year limited warranty
- Capacity: 11000 lbs.
- Fork Width: 6-1/4"
- Raised Height: 5.5"
- Lowered Height: 3"

Model No.	Overall Fork Dim.	
	Width"	Length"
M0890	27	48

HYDRAULIC PALLET TRUCKS

ALL PALLET TRUCKS ON THIS PAGE
HAVE A 2-YEAR LIMITED WARRANTY

6' LONG FORK HYDRAULIC PALLET TRUCKS

- Heavy-duty polyurethane tread bonded to cast iron core steering wheels and rollers provide superior performance
- Nylon exit roller facilitates entry and exit of pallets
- 6-1/4" (158.75 mm) wide forks
- Lowered pallet truck height: 3"
- Raised pallet truck height: 7-5/8"
- Colour: Yellow

Model No.	Overall Fork Dim.		Capacity lbs.
	Width"	Length"	
MN723	27	72	3300
MN459	27	72	5500



3300 LB - 5500 LB.
CAPACITY

GALVANIZED HYDRAULIC PALLET TRUCKS

- Heavy-duty all nylon steering wheels and rollers provide superior mobility and performance
- Nylon exit roller facilitates entry and exit of pallets
- 6-1/4" (158.75 mm) wide forks
- Lowered pallet truck height: 3"
- Raised pallet truck height: 7-1/16"
- Galvanized finish offers corrosion resistance and is ideal for wet and cold conditions

Model No.	Overall Fork Dim.	
	Width"	Length"
MN648	27	42
MN059	27	48



5500-LB.
CAPACITY

STAINLESS STEEL HYDRAULIC PALLET TRUCKS

- Heavy-duty all nylon steering wheels and rollers provide superior mobility and performance
- Nylon exit roller facilitates entry and exit of pallets
- 6-1/4" (158.75 mm) wide forks
- Lowered pallet truck height: 3"
- Raised pallet truck height: 7-1/16"
- High grade 304 Stainless steel is ideal for medical, food, sanitary, pharmaceutical, wet and cold applications

Model No.	Overall Fork Dim.	
	Width"	Length"
MN060	27	48



5500-LB.
CAPACITY

ALL PALLET TRUCKS ON THIS PAGE
HAVE A 2-YEAR LIMITED WARRANTY

HYDRAULIC PALLET TRUCKS



**5500-LB.
CAPACITY**

LOW PROFILE HYDRAULIC PALLET TRUCKS

- Permits the handling of pallets and containers that are lower than the standard height
- Heavy-duty polyurethane tread bonded to cast iron core steering wheels and all steel rollers provide superior performance
- 1.5" exit ramp facilitates exit of pallets
- 6" (152 mm) wide forks
- Lowered pallet truck height: 2"
- Raised pallet truck height: 5-1/2"
- Colour: Orange

Model No.	Overall Fork Dim.	
	Width"	Length"
MN061	27	48



**5500-LB.
CAPACITY**

MULTI-DIRECTIONAL HYDRAULIC PALLET TRUCKS

- Transrollers permit lateral movement in addition to forward/backward
- Heavy-duty polyurethane tread bonded to cast iron core steering wheels provide superior performance
- Double load rollers, one polyurethane tread bonded to cast iron core and one nylon for easy moving of extra heavy loads
- 2-1/5" exit ramp facilitates exit of pallets
- 6-1/4" (158.75 mm) wide forks
- Lowered pallet truck height: 3"
- Raised pallet truck height: 7-1/2"
- Capacity: Up to 5500 lbs. in standard mode, and up to 3300 lbs. in lateral mode
- Colour: Orange

Model No.	Overall Fork Dim.	
	Width"	Length"
MN062	27	48



**4400-LB.
CAPACITY**

DIGITAL SCALE HYDRAULIC PALLET TRUCKS

- Permits the weighing of skids and containers while handling them
- Mettler Toledo digital cUL approved scale offers maximum precision on load weights
- Heavy-duty polyurethane tread bonded to cast iron core steering wheels and rollers provide superior performance
- Nylon roller facilitates entry and exit of pallets
- 6-5/8" (168 mm) wide forks
- Lowered pallet truck height: 3"
- Raised pallet truck height: 7-11/16"
- Colour: Orange

Model No.	Overall Fork Dim.	
	Width"	Length"
MN705	27	44-1/2

PALLET HANDLING EQUIPMENT

FORK EXTENSIONS

- Handle large and odd shaped loads with increased stability
- Easy to use slide-on design
- Steel retaining strap prevents extensions from sliding off during use
- Fork extension not to exceed 50% more than existing fork length
- Available in 4" and 5" fork widths, with lengths of 72" and 96"

Model No.	Accommodates Fork Width"	Fork Extension Overall Width"	Length"	Wt. lbs.
M0778	4	5	54	84
M0779	4	5	63	98
ML346	4	5	72	114
M0780	4	5	84	145
ML348	4	5	96	172
ML347	5	6	72	128
M0781	5	6	63	110
M0782	5	6	84	160
M0783	5	6	96	191
M0784	6	7	72	134
M0785	6	7	84	186
M0786	6	7	96	213

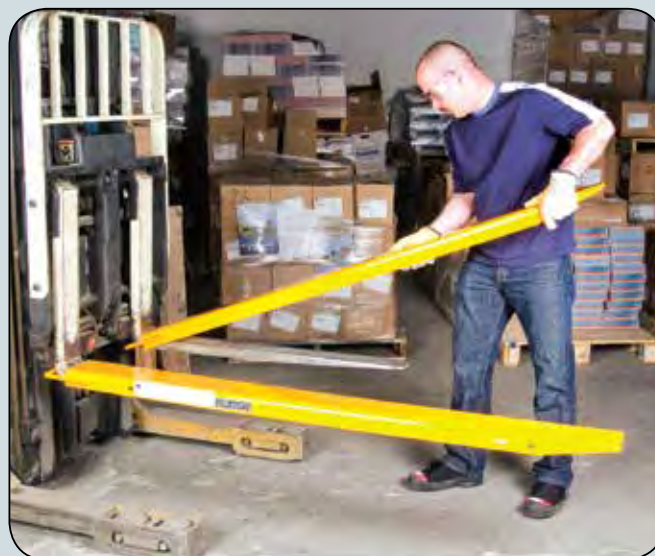

WALL BRACKETS

- All welded heavy-duty
- To keep fork extensions out of the way when not in use
- One wall bracket required for each pair of forks
- KLETON safety yellow

Model No.	Dimensions W" x H"	Wt. lbs.
ML282	6 x 8	5

Hardware not included



PALLET HANDLING EQUIPMENT

ZINC PLATED QUICK LINKS

- Multi-purpose connector
- Not approved for climbing applications



Model No.	Working Load Limit	Size"
LW266	220 lbs (0.11 Tons)	1/8
LW267	660 lbs (0.33 Tons)	3/16
LW268*	880 lbs (0.44 Tons)	1/4
LW269*	1760 lbs (0.88 Tons)	5/16
LW270*	2140 lbs (1.07 Tons)	3/8
LW271*	3300 lbs (1.65 Tons)	1/2

*Working load limit (WLL) stamped on each piece

SNAP HOOKS

- Multi-purpose connector
- Not approved for climbing applications

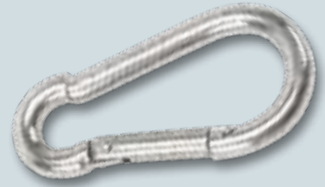

Model No.	Material	Working Load Limit	Size"	Eye Size"
LW272*	Stainless Steel	220 lbs (0.11 Tons)	3/16	5/16
LW273	Zinc Plated	220 lbs (0.11 Tons)	3/16	5/16
LW274*	Stainless Steel	260 lbs (0.13 Tons)	1/4	3/8
LW275*	Zinc Plated	500 lbs (0.25 Tons)	5/16	1/2
LW276*	Stainless Steel	500 lbs (0.25 Tons)	5/16	1/2
LW277*	Stainless Steel	770 lbs (0.385 Tons)	3/8	5/8

*Working load limit (WLL) stamped on each piece

HYDRAULIC PLATFORM LIFT STACKER

- Allow workers to manoeuver and lift heavy loads safely to comfortable needed height
- Foot pedal folds safely out of the way
- Front 5" polyurethane casters and rear 3" polyurethane wheels allow loads to move easily
- Lowered platform height: 4"
- Raised platform height: 60"
- Capacity: 880 lbs.

Model No.	Overall Dimensions	Platform Dimensions	Wt. lbs.
	W" x D" x H"	W" x D"	
MN397	23 x 39 x 67-3/4	23 x 25-3/4	174



PALLET PULLERS

- Efficient way to unload pallets from trucks
- Hardened teeth give positive grip in any pallet
- One-person operation
- Pulls pallets straight or sideways to get out of tight spots

Model No.	Description	Wt. lbs.
KH863	Pallet Puller	16
LU982	20' Hook and Chain	21



Model LU982
OPTIONAL 20' HOOK AND CHAIN



KH863

5000-LB. CAPACITY

SPRING-OPERATED PALLET LIFTER

- Shock absorber and heavy-duty springs allow the top of the load to remain at a convenient height by raising and lowering the pallet as its weight changes
- Equipped with forklift pockets for easy relocation
- Rotating top minimizes worker movement
- Ergonomic design helps prevent workplace injuries
- Base Frame Dimensions: 45-1/4" L x 36-3/4" W
- Platform Dimensions: 43-5/8" L x 43-5/8" W
- Easy to assemble
- Capacity: 4400 lbs.
- Raised Height: 27.75"
- Lowered Height: 9.5"
- Frame Material: Steel

Model No. **M0787**



KLETON

CHAIN HOISTS

CHAIN HOISTS

- Lightweight steel construction
- Triple-spur geared for easy lifting
- Load brake assures safety and load control
- High tensile alloy steel load chain for increased strength and durability for added security
- Latched swivel hooks for added security
- Enclosed chain guide ensures dirt and dust do not affect operation

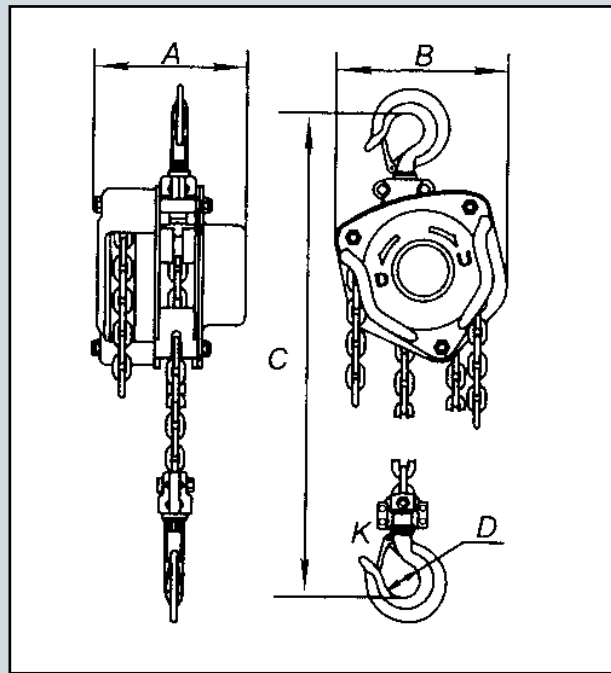

Model No. 10' Lift	Model No. 20' Lift	Capacity			Net Weight		No. of Falls Chain	Load Chain Dia.		Headroom	
		Tons	lbs.	kg.	lbs.	kg		in.	mm	in.	mm
LS534	LS540	1/2	1000	450	22	10	1	1/4	6	10-1/2	270
LS535	LS541	1	2000	900	26.4	12	1	1/4	6	12-1/2	317
LS536	LS542	1-1/2	3000	1360	40.7	18.5	1	5/16	8	15-3/4	399
LS537	LS543	2	4000	1800	44	20	1	5/16	8	16-1/4	414
LS538	LS544	3	6000	2720	63.8	29	2	5/16	8	18-1/4	465
LS539	LS545	5	10000	4530	100	45.5	2	7/16	10	25	636

Model No. 10' Lift	Model No. 20' Lift	A		B		C		D		K	
		in.	mm	in.	mm	in.	mm	in.	mm	in.	mm
LS534	LS540	5-1/4	131	5	127	10-1/2	270	1-3/8	36	1-3/16	30
LS535	LS541	5-1/2	140	6-1/4	158	12-1/2	317	1-5/8	40	1-1/4	34
LS536	LS542	6-1/4	161	7-1/4	187	15-3/4	399	1-3/4	45	1-1/2	38
LS537	LS543	6-1/4	161	7-1/4	187	16-1/4	414	2	50	1-5/8	41
LS538	LS544	6-1/4	161	8-1/4	210	18-1/4	465	2-1/4	58	1-7/8	48
LS539	LS545	7-1/4	186	10	253	25	636	2-1/2	64	2	52

*Dimensions are approximate and should be confirmed if important to your application

LEVER HOISTS

LEVER HOISTS

- Lightweight steel construction
- Short steel handle rotates 360° to allow operation in any position
- Load brake assures safety and load control
- High tensile alloy steel load chain for increased strength and durability
- Latched swivel hooks for added security
- Enclosed chain guide ensures dirt and dust do not affect operation

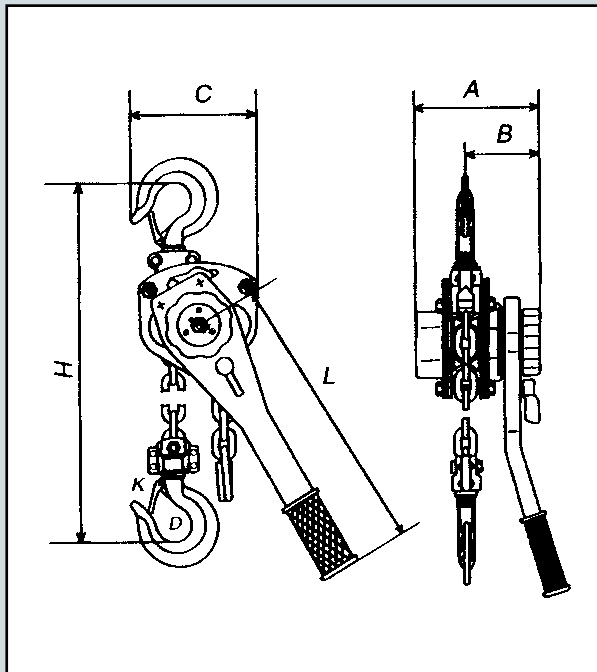

Model No.	Capacity			Net Weight		No. of FallsChain	Load Chain Dia.	
	Tons	lbs.	kg.	lbs.	kg.		in.	mm
5' Lift								
LS546	3/4	1500	680	15.5	7	1	1/4	6
LS547	1	2000	900	17.6	8	1	1/4	6
LS548	1-1/2	3000	1360	24	11	1	5/16	8
LS549	3	6000	2720	46	21	1	7/16	10
LS550	6	12000	5440	68	31	2	7/16	10

Model No.	A		B		C		D		H		L		K	
	in.	mm	in.	mm	in.	mm	in.	mm	in.	mm	in.	mm	in.	mm
5' Lift														
LS546	5-3/4	148	3-1/2	90	5-1/4	136	1-1/2	40	12-3/4	325	11	280	1-5/16	34
LS547	5-3/4	148	3-1/2	90	5-1/4	136	1-1/2	40	12-3/4	325	11	280	1-5/16	34
LS548	6-3/4	172	3-3/4	98	6-1/4	160	1-3/4	45	15	380	16	410	1-7/16	38
LS549	7-3/4	200	4-1/2	115	7	180	2-1/4	58	18-3/4	480	16	410	1-7/8	48
LS550	7-3/4	200	4-1/2	115	9-1/4	235	2-1/2	64	24-1/2	620	16	410	2-1/16	52

* Dimensions are approximate and should be confirmed if important to your application

ADJUSTABLE TROLLEYS



- Easily adjusts to fit various flangers and I-beams
- Use on straight or curved track
- Can be installed or removed at any position on the beam
- Heavy-duty cast iron wheels
- Safety plate included
- Deep width flange provides superior contact with the beam
- Geared trolleys include 2 geared wheels operated by hand chain

PLAIN TROLLEYS

Model No.	Capacity			I-Beam Flange Width		Min. Curve Radius		Net Weight	
	Tons	lbs.	kg	in.	mm	in.	mm	lbs.	kg
LS551	1/2	1000	450	2-11/16 - 5-3/8	68-136	35-7/16	900	10	4.4
LS552	1	2000	900	3-1/8 - 6-1/4	80-158	39-3/8	1000	17	7.5
LS553	2	4000	1800	3-1/8 - 6-1/4	80-158	43-5/16	1100	28	12.5
LS554	3	6000	2720	3-7/16 - 7-3/8	88-188	51-3/16	1300	46	20.6
LS555	5	10000	4530	4-13/16 - 9-9/16	122-243	66-15/16	1700	73	33

* Dimensions are approximate and should be confirmed if important to your application

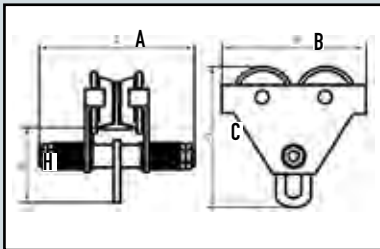

Model No.	Capacity Tons	A		B		C		D	
		in.	mm	in.	mm	in.	mm	in.	mm
LS551	1/2	8-3/16	208	8	202.4	7-3/8	187	4-59/64	125
LS552	1	9-1/2	242	9-11/64	233	7-3/4	197.7	5	127.5
LS553	2	9-27/32	250	10-11/32	262.6	9-23/64	237.5	5-53/64	148
LS554	3	11-13/16	300	11-3/4	298	11-7/8	301	7-23/32	196
LS555	5	13-1/2	343	13-3/4	349	13-3/8	340	8-37/64	218



- Easily adjusts to fit various flangers and I-beams
- Use on straight or curved track
- Can be installed or removed at any position on the beam
- Heavy-duty cast iron wheels
- Safety plate included
- Deep width flange provides superior contact with the beam
- Geared trolleys include 2 geared wheels operated by hand chain

GEARED TROLLEYS

Model No.	Capacity			I-Beam Flange Width		Min. Curve Radius		Net Weight	
	Tons	lbs.	kg	in.	mm	in.	mm	lbs.	kg
LS556	1/2	1000	450	2-11/16 - 5-1/4	68-134	35-7/16	900	18	8
LS557	1	2000	900	3-1/8 - 5-15/16	80-150	39-3/8	1000	25	11.5
LS558	2	4000	1800	3-1/8 - 7-1/16	80-180	43-5/16	1100	36	16.5
LS559	3	6000	2720	3-7/16 - 7-3/8	88-188	51-3/16	1300	54	24.5
LS560	5	10000	4530	4-3/4 - 7-3/4	120-196	55-1/8	1400	81	36.6

* Dimensions are approximate and should be confirmed if important to your application

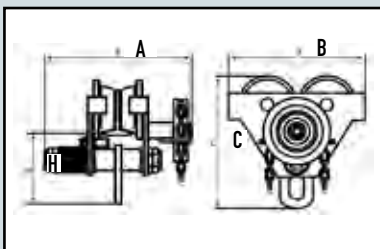

Model No.	Capacity Tons	A		B		C		H	
		in.	mm	in.	mm	in.	mm	in.	mm
LS556	1/2	9-3/4	248	8	202.5	7-13/32	188	4-59/64	125
LS557	1	11	280	9-1/4	235	7-3/4	197	4-31/32	126
LS558	2	12-1/2	318	10-5/32	258	9-3/8	238	5-29/32	150
LS559	3	13-3/8	340	11-1/2	293	11-3/4	298	7-31/64	190
LS560	5	14-3/8	365	13-3/4	350	13-11/32	339	8-5/8	219

HAND TRUCKS

CAUTION For worker safety and in order to protect your equipment please be advised that all hand trucks on this page are not meant for use on stairs or steps. Please see our Appliance Trucks on Page 25 or Aluminum Hand Trucks on Pages 22-24



MK728

MK729

MN103

RUBBER WHEEL HAND TRUCKS

**600-LB.
CAPACITY**

- Constructed of 1" 16-gauge steel tube
- Nose plate 7-gauge steel
- Overall width: 19-1/2"
- Wheel dimensions: 8" x 2"
- Powder coated

Model No.	Description	Height"	Nose Plate Dim. W" x D"	Wt. lbs.
MK728	Continuous Handle	46	14 x 8-1/2	23
MK729	Dual Handle	48	14 x 8-1/2	24
MN103	P-Handle	51	14 x 9	24

REPLACEMENT PARTS

Model No. ML812, Rubber Wheel

Model No. MK993, Hand Grip



MH301

MH300

MH302

PNEUMATIC WHEEL HAND TRUCKS

**600-LB.
CAPACITY**

- Constructed of 1" 16-gauge steel tube
- Nose plate 8 gauge steel
- Overall width: 21-1/2"
- Wheel dimensions: 10" x 3"
- Powder coated

Model No.	Description	Height"	Nose Plate Dim. W" x D"	Wt. lbs.
MH300	Dual Handle	46	14 x 9	23
MH301	Continuous Handle	48	14 x 9	26
MH302	P-Handle	51	14 x 9	23

REPLACEMENT PARTS

Model No. ML810, Pneumatic Wheel

Model No. MK993, Hand Grip

FLAT FREE WHEEL HAND TRUCKS

**600-LB.
CAPACITY**

- Constructed of 1" 16-gauge steel tube
- Nose plate 8-gauge steel
- Overall width: 22"
- Wheel dimensions: 10" x 3-1/2"
- Powder coated

Model No.	Description	Height"	Nose Plate Dim. W" x D"	Wt. lbs.
MN389	Dual Handle	46	14 x 9	20
MN390	Continuous Handle	48	14 x 9	22
MN391	P-Handle	51	14 x 9	22

REPLACEMENT PARTS

Model No. MN378, Flat Free Wheel

Model No. MK993, Hand Grip



MN389

MN390

MN391



CAUTION For worker safety and in order to protect your equipment please be advised that all hand trucks on this page are not meant for use on stairs or steps. Please see our Appliance Trucks on Page 25 or Aluminum Hand Trucks on Pages 22-24

HAND TRUCKS

HEAVY-DUTY RUBBER WHEEL HAND TRUCKS

- Constructed of 1-1/4" 14-gauge steel tube
- Nose plate 6-gauge steel
- Overall width: 20"
- Wheel dimensions: 8" x 2"
- Powder coated

**1000-LB.
CAPACITY**

Model No.	Description	Height"	Nose Plate Dim. W" x D"	Wt. lbs.
M0119	Continuous Handle	50	14 x 8-3/4	28
MK730	Dual Handle	46	14 x 8	36
M0121	P-Handle	50-3/4	14 x 8-3/4	29

REPLACEMENT PARTS

Model No. **ML813**, Rubber Wheel
Model No. **MK993**, Hand Grip



HEAVY-DUTY PNEUMATIC WHEEL HAND TRUCKS

- Constructed of 1-1/4" 14-gauge steel tube
- Nose plate 6-gauge steel
- Overall width: 20"
- Wheel dimensions: 10" x 3"
- Powder coated

**800-LB.
CAPACITY**

Model No.	Description	Height"	Nose Plate Dim. W" x D"	Wt. lbs.
M0120	Continuous Handle	50-3/4	14 x 8-3/4	29
MK731	Dual Handle	46	14 x 8	36
M0122	P-Handle	50 3/4	14 x 8-3/4	29

REPLACEMENT PARTS

Model No. **ML811**, Pneumatic Wheel
Model No. **MK993**, Hand Grip



TRAFFIC CONE CART

- Constructed of 1" round heavy-duty 14 gauge steel tubing
- Holds up to 25 standard or reflective cones from 12" to 28" in height
- Overall width: 22-1/2"
- Wheel dimensions: 10" x 3"
- Powder coated

**500-LB.
CAPACITY**

Model No.	Overall Dimensions W" x D" x H"	Load Capacity lbs.	Wt. lbs.
M0214	22-1/2 x 20 x 45	500	32

Safely and easily transports traffic cones with little effort!



HAND TRUCKS

CAUTION For worker safety and in order to protect your equipment please be advised that all hand trucks on this page are not meant for use on stairs or steps. Please see our Appliance Trucks on Page 25 or Aluminum Hand Trucks on Pages 22-24



CONVERTIBLE DELUXE STEEL HAND TRUCK

- Constructed of 1" round 14-gauge steel tubing
- Quickly converts from a two-wheel hand truck to a four-wheel platform truck
- Comes with two welded-on stair glides
- 8" x 14" nose plate
- Two 10" full pneumatic wheels and two 3" bolted-on casters
- Durable Kleton blue enamel finish



700-LB. CAPACITY

Model No.	Overall Dimensions W" x D" x H"	Wt. lbs.
ML320	14 x 43 x 46	75

DELUXE 12" NOSE PLATE HAND TRUCKS

- Constructed of 1" round 14-gauge steel tubing
- Transport short to tall loads easily
- P-handle ideal for one hand control
- Strong 12" x 14" x 3/16" thick nose plate
- Double welded 3/16" x 1-1/2" cross bars
- Add a folding nose extension to be able to transport larger loads
- Two 10" full pneumatic wheels
- Durable Kleton blue enamel finish

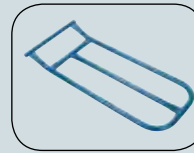

Model ML323 Nose Extension



600-LB. CAPACITY

Model No.	Description	Overall Dimensions W" x H"	Wt. lbs.
ML321	Lo-Boy	23 x 50	40
ML322	Hi-Boy	23 x 72	46
ML323	Nose extension	12" x 22" Nose Length	8

HEAVY-DUTY SPADE TRUCK

- Constructed of double-welded 1-1/4" round 14-gauge steel tubing
- Oversized nose plate and easy grip frame helps with the balancing of larger items
- Tapered 22" x 1/4" x 13" deep thick nose plate
- Two 10" Mold-on rubber wheels
- Durable Kleton blue enamel finish



1200-LB. CAPACITY

Model No.	Dimensions W" x H"	Wt. lbs.
ML324	22" x 53"	92

HAND TRUCK ATTACHMENTS

- Constructed of 1" 14-gauge steel tubing
- Allows extra versatility to adapt to changing material handling requirements without the extra cost
- Easy to install
- Designed to fit most hand trucks with a 14" frame width
- Durable KLETON blue enamel finish



MA378



Model No.	Description	Wt. lbs.
MA378	Chair Mover Attachment	15
MA385	Table Mover Attachment	25



CAUTION For worker safety and in order to protect your equipment please be advised that all hand trucks on this page are not meant for use on stairs or steps. Please see our Appliance Trucks on Page 25 or Aluminum Hand Trucks on Pages 22-24

HAND TRUCKS & GAS CYLINDER CARTS

LOAD RETENTION HAND TRUCK

- Constructed of 1" round 14-gauge steel tubing
- 18-1/2" x 53" load retention grill to safely handle wide and awkward loads
- 7-gauge steel nose plate
- 18-1/2" x 9-3/4" nose plate
- Two 10" full pneumatic wheels
- Durable Kleton blue enamel finish

Model No. **MN412**



MN412

600-LB. CAPACITY

MINI-MIG WELDING CART

- Designed to carry a variety of Mini-MIG, Inverters, and Plasma machines
- Dimensions: 18" W x 36" D x 17" H
- Weight: 48 lbs.
- Cylinder Capacity: 9.5"

Model No. **ML419**

1000-LB. CAPACITY



ML419

HEAVY-DUTY DUAL HANDLE HAND TRUCK

- Constructed of 1-1/4" 14-gauge steel tubing
- 6-gauge steel 12" x 8" nose plate
- Overall width: 20"
- Overall height: 46"
- Weight: 40 lbs.
- Two 10" rubber wheels
- Powder coated

Model No. **MA376**

600-LB. CAPACITY



REPLACEMENT PARTS

Model No. **MN694**, Rubber Wheel
Model No. **ML030**, Hand Grip

GAS CYLINDER CARTS

- Choice of carts for a wide range of cylinder sizes and terrains.



ML414



ML416



ML417

Model No.	Wt. lbs.	Base W" x D"	Wheels	Capacity
ML413	55	25 x 13	16" Diameter Pneumatic	224 cu. ft. Oxygen, 300 cu. ft. Acetylene Cylinders
ML414	22	12 x 10	10" Diameter Semi-Pneumatic	300 cu. ft. 9" Diameter Cylinder
ML415	55	25 x 13	14" Diameter x 3" Rubber	244 cu. ft. Oxygen, 300 cu. ft. Acetylene Cylinders
ML416	27	12 x 16	10" Diameter Semi-Pneumatic	144 cu. ft. or 244 cu. ft. Oxygen, 130 cu. ft. Acetylene Cylinders
ML417	30	19 x 10	10" Diameter Semi-Pneumatic	144 cu. ft. or 244 cu. ft. Oxygen, 130 cu. ft. Acetylene Cylinders

ALUMINUM HAND TRUCKS

HAND TRUCK ACCESSORIES

NOSE EXTENSIONS

- Size 20"
- Only compatible with cast nose plates

Model No. **MN019**

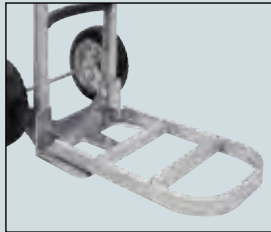

STAIR CLIMBERS

Model No. **MN015**



FRAME EXTENSIONS

Size: 17"

Model No. **MN021**

Size: 23"

Model No. **MN022**



REPLACEMENT WHEELS



10" PNEUMATIC

Model No. **MN012**



8" MOLD-ON RUBBER

Model No. **MN013**



10" FLAT-FREE

Model No. **MN014**

RUBBER WHEEL ALUMINUM HAND TRUCKS

- Strong lightweight hand truck provides exceptional durability and versatility
- Weld-free construction for easy maintenance
- Wheel Size: 8" H x 2" W
- Capacity: 500 lbs.
- Shipped knocked down



Model No.	Handle Type	Overall Dimensions W" x H"	Nose Plate Dimensions W" x D"
M0073	P-Handle	14 x 52	14 x 7-1/2
MN027	P-Handle	21 x 48	18 x 7-1/2
MN024	Continuous	16 x 48	14 x 7-1/2

Model No.	Handle Type	Overall Dimensions W" x H"	Nose Plate Dimensions W" x D"
MN025	Continuous	20 x 48	18 x 7-1/2
M0891	Dual Handle	20 x 52	18 x 7-1/2
M0892	Continuous	20 x 48	18 x 7-1/2

ALUMINUM HAND TRUCKS



FLAT-FREE WHEEL ALUMINUM HAND TRUCKS

- Strong lightweight hand truck provides exceptional durability and versatility
- Weld-free construction for easy maintenance
- Wheel Size: 10" H x 3" W
- Capacity: 500 lbs.
- Shipped knocked down



M0080



M0078



M0077



M0896



M0075



M0072



MN032



MN029



M0898

Model No.	Handle Type	Overall Dimensions W" x H"	Nose Plate Dimensions W" x D"
M0080	P-Handle	18 x 52	18 x 7-1/2
M0078	Continuous	14 x 48	14 x 7-1/2
M0077	Continuous	18 x 48	18 x 10
M0896	Continuous	18 x 48	18 x 7-1/2

Model No.	Handle Type	Overall Dimensions W" x H"	Nose Plate Dimensions W" x D"
M0075	Continuous	14 x 52	14 x 7-1/2
M0072	Dual Handle	18 x 52	18 x 7-1/2
MN032	Dual Handle	18 x 52	18 x 10
MN029	P-Handle	18 x 52	18 x 7-1/2
M0898	P-Handle	16 x 52	14 x 7-1/2

ALUMINUM HAND TRUCKS

PNEUMATIC WHEEL ALUMINUM HAND TRUCKS

- Weld-free construction for easy maintenance
- Strong and lightweight hand truck provides exceptional durability and versatility
- Shipped knocked down
- Wheel Size: 10" H x 3" W
- Capacity: 500 lbs.
- Shipped knocked down



M0079



M0074



MN026



MN031



M0076



M0071



MN030



MN033



MN028

Model No.	Handle Type	Overall Dimensions W" x H"	Nose Plate Dimensions W" x D"
M0079	P-Handle	18 x 52	18 x 7-1/2
M0076	Continuous	18 x 48	18 x 10
M0074	P-Handle	14 x 52	14 x 7-1/2
M0071	Dual Handle	18 x 52	18 x 7-1/2
M0893	Continuous	16 x 48	14 x 7-1/2
M0894	P-Handle	18 x 52	18 x 7-1/2

Model No.	Handle Type	Overall Dimensions W" x H"	Nose Plate Dimensions W" x D"
MN026	Continuous	16 x 52	14 x 7-1/2
MN030	Dual Handle	16 x 52	14 x 7-1/2
MN031	Dual Handle	18 x 52	18 x 10
MN033	Dual Handle	21 x 52	18 x 7-1/2
M0895	Continuous	16 x 48	14 x 7-1/2
MN028	P-Handle	18 x 52	18 x 7-1/2

SPECIALIZED HAND TRUCKS

CONVERTIBLE HAND TRUCKS

- Converts easily from a 2-wheel hand truck to a 4-wheel platform truck
- Lightweight aluminum construction
- Caster and wheel type:
ML621: 5" polyurethane casters and 10" flat free wheels
M0068: 5" polyurethane casters and 10" pneumatic wheels
- Shipped assembled

Model No.	Nose Plate W" x D"	Hand Truck		Platform Truck		Wt. lbs.
		Cap. lbs.	Ht. "	Cap. lbs.	L" x W"	
ML621	18 x 10	600	52	1250	43 x 12	46,5
M0068	18 x 7-1/2	550	62	800	56 x 20	42

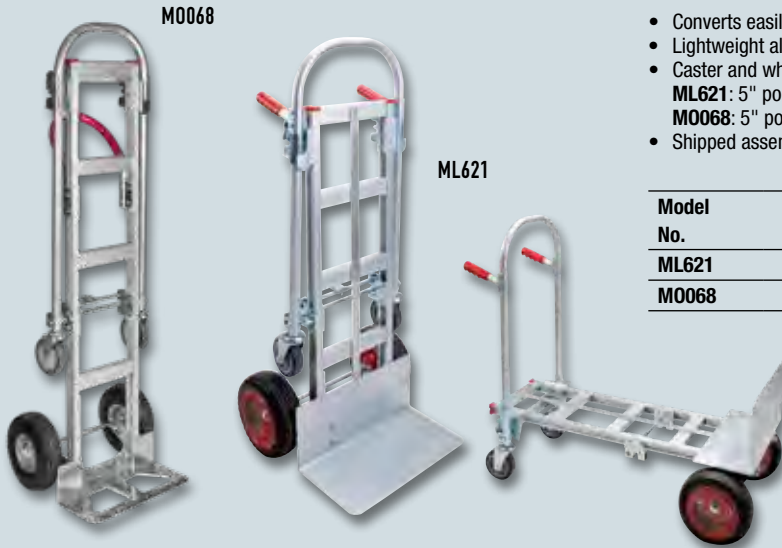

APPLIANCE TRUCKS

- Move large appliances easily
- Heavy-duty all welded industrial construction
- Vinyl bumpers on face of truck to prevent damage to appliances
- Heavy-duty continuous stair climbers for easy climbing/descending
- 8" solid rubber front wheels
- **ML617** comes with fold out rear legs with two 4" swivel casters
- Ratchet mechanism for easy fastening of loads

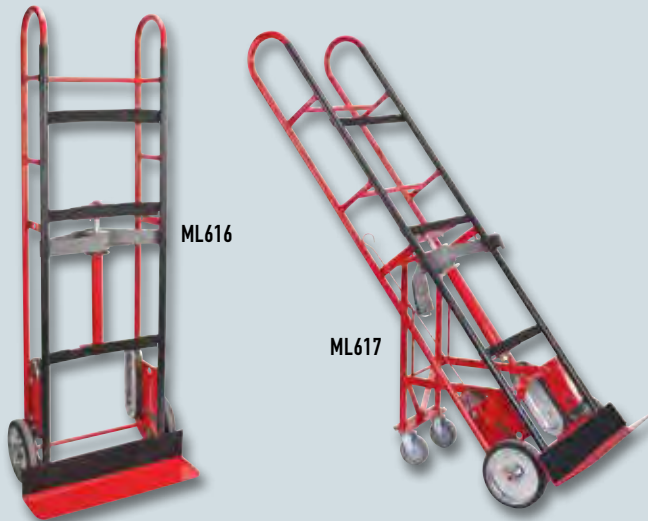

Model No.	Description	Overall Dimensions L" x W" x H"	Cap. lbs.	Wt. lbs.
ML616	Appliance Truck	14-1/2" x 24" x 59"	550	46
ML617	Vending Machine Appliance Truck	14-1/2" x 24" x 66"	850	65

FOLDING ALUMINUM HAND TRUCK

175-LB. CAPACITY

- Lightweight and durable aluminum construction
- Convenient folding design permits storage in small spaces
- Comfortable ergonomic handle
- Elastic straps help to secure load
- Non-marking and shock-absorbing rubber wheels
- Extended Dimensions: 39-5/8" L x 15-1/2" W x 16-1/2" H
- Folded Dimensions: 25" L x 15" W x 2-3/8" H



Model No.	Nose Plate W" x D"	Wheel Size"	Wt. lbs.
ML447	15-1/4 x 11	5 x 1-1/4	8.75

POLYETHYLENE TILT TRUCKS

POLYETHYLENE TILT TRUCKS

- Ideal for transporting and dumping waste, scrap and other bulk materials
- Polyethylene body is mounted on an all-welded steel chassis
- Includes small swivel caster(s) at the front and large fixed wheels at the rear



MN980



MN981



MN982



MN983

Model No.	Durability	Overall Dimensions L" x W" x H"	Capacity Cu.yd.	Capacity lbs.	Front Wheel Type	Rear Wheel Type
MN980	Light Duty	57 x 28 x 38	5/8	500	8" Mold-On Rubber	4" Non-Marking Rubber
MN981	Standard Duty	57 x 28 x 38	5/8	850	10" Mold-On Rubber	5" Non-Marking Rubber
MN982	Standard Duty	66 x 34 x 43	1.1	1250	12" Mold-On Rubber	5" Non-Marking Rubber
MN983	Heavy Duty	66 x 34 x 43	1.1	2000	12" Mold-On Rubber	5" Non-Marking Rubber

REPLACEMENT PARTS FOR MN982 AND MN983

Model No. **ML846**, 5" Mold-on Rubber Swivel Caster

Model No. **MN693**, 12" Mold-on Rubber Wheel

REPLACEMENT PARTS FOR MN981 AND MN982

Model No. **ML337**, 5" Non-Marking Rubber Swivel Caster

Model No. **MN694**, 10" Mold-on Rubber Wheel

BOX TRUCKS & SELF DUMPING HOPPERS

MN985



MN984



HEAVY-DUTY POLYETHYLENE BOX TRUCKS

- Seamless durable 100% polyethylene bins
- Leakproof and easy to clean
- Available with 3/4" treated plywood undercarriage or all-welded steel chassis with a durable Kleton blue enamel finish
- Includes 2 swivel and 2 rigid casters
- Capacity is based on evenly distributed weight
- Stackable for storage
- Caster type: 3" Polyolefin
- Bin colour: Black
- Bin material: Polyethylene
- Caster placement: Corner standard
- Tapered walls

Model No.	Base	Capacity Cu. ft.	Capacity lbs.	Overall Dimensions L" x W" x H"
MN984	Plywood	9	500	37 x 26 x 30
MN985	Steel Chassis	9	800	37 x 26 x 30
MN986	Plywood	12	500	39 x 27 x 30
MN987	Steel Chassis	12	800	39 x 27 x 30
MN988	Plywood	16	500	43 x 30 x 33
MN989	Steel Chassis	16	800	43 x 30 x 33

REPLACEMENT PARTS

Model No. **ML391**, 3" Swivel Polyolefin Caster



KNOCKED-DOWN SELF DUMPING HOPPERS

- Economical alternative to all-welded self-dumping hoppers
- Ships knocked down in a well packaged wood crate
- Simply bolt together panels, gears and latch to the fully assembled base
- Fork lift-operated self-dumping hopper
- Designed specifically for efficient handling of scrap metal, raw materials and other bulk materials
- Spring loaded (pull-down) lever system, safe when dumping at heights and can be dumped from the ground
- Removable pin system allows for easy, user friendly repairs
- 12-gauge panels can easily be replaced (Panels sold separately)
- Material: Galvanized Steel
- Base Thickness: 7 Gauge
- Load Capacity: 2000 lbs.

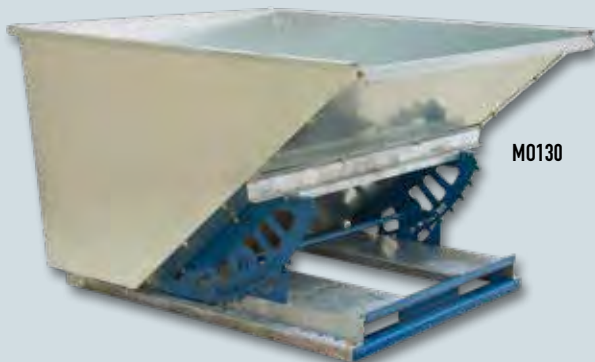

M0130

Model No.	Overall Dimensions W" x D" x H"	Capacity Cu. yd.
M0130	39 x 44-3/4 x 28-1/2	5/8
M0131	48-1/2 x 50 x 31	1
M0132	61-1/2 x 55 x 34	1-1/2

REPLACEMENT PARTS

Model No. **M0247**, Caster Set

POLY BOX TRUCKS

HEAVY-DUTY WHITE WALL POLY BOX TRUCKS

- Seamless durable 100% polyethylene bins
- Leakproof and easy to clean
- Available with 3/4" treated plywood undercarriage or all-welded steel chassis with a durable Kleton blue enamel finish
- Includes 2 swivel and 2 rigid casters
- Capacity is based on evenly distributed weight
- Caster type: 4" non-marking blue rubber
- Bin colour: White
- Bin material: White polyethylene
- Caster placement: Corner standard



MN992

Model No.	Base	Capacity cu. ft.	Capacity lbs.	Overall Dimensions L" x W" x H"
-----------	------	------------------	---------------	---------------------------------

TAPERED WALL

MN990*	Plywood	7	600	33 x 20 x 29
MN991*	Steel Chassis	7	1000	33 x 20 x 29
MN992*	Plywood	9	600	37 x 26 x 31
MN993*	Steel Chassis	9	1000	37 x 26 x 31
MN994*	Plywood	12	600	39 x 27 x 31
MN995*	Steel Chassis	12	1000	39 x 27 x 31
MN998*	Plywood	16	600	43 x 30 x 34
MN999*	Steel Chassis	16	1000	43 x 30 x 34

STRAIGHT WALL

MN996	Plywood	14	600	46 x 28 x 31
MN997	Steel Chassis	14	1000	46 x 28 x 31
M0001	Plywood	22	600	57 x 34 x 33
M0002	Steel Chassis	22	1000	57 x 34 x 33
M0003	Plywood	25	600	51 x 33 x 39
M0004	Steel Chassis	25	1000	51 x 33 x 39

*Stackable for storage



MN995

REPLACEMENT CASTERS FOR TAPERED WALL TRUCKS

Model No	Description
ML334	4" Rigid Non-Marking Rubber Caster
ML333	4" Swivel Non-Marking Rubber Caster

REPLACEMENT CASTERS FOR STRAIGHT WALL TRUCKS

Model No.	Swivel Type	Caster Type
ML334	Rigid	4" Non-Marking Rubber
ML333	Swivel	4" Non-Marking Rubber
ML338	Rigid	5" Non-Marking Rubber
ML337	Swivel	5" Non-Marking Rubber
MN445	Rigid	5" Sandwich
MN444	Swivel	5" Sandwich
ML862	Rigid	6" Hi-Temp Nylon
ML861	Swivel	6" Hi-Temp Nylon

Please see pages 58-61 to determine which caster best suits your specific needs.



MN996



Customize KLETON
products to your specs!
See Inside Front Cover

POLY BOX TRUCKS & MESH STOCK TRUCKS

EASY ACCESS POLY BOX TRUCK

- Drop-style side wall allows for easy loading and unloading
- Volume Capacity: 22 cu. ft.
- Weight Capacity: 1000 lbs.
- Bin Material: Polyethylene
- Caster Placement: Corner Standard
- Caster Type: 4" Non-Marking Blue Rubber
- Bin Colour: Grey
- Base Type: Plywood



Model No	Volume Capacity	Dimensions L" x W" x H"	Caster Size
MP035	22 cu. ft.	45-3/4 x 31-1/4 x 37-3/4	4" Non-Marking Blue Rubber
MP036	24 cu. ft.	63 x 34-1/4 x 38-1/2	5" Non-Marking Blue Rubber

WIRE MESH STOCK TRUCK

- Rugged all-welded steel construction, ready to use
- Designed for efficient loading/unloading and transportation of merchandise
- Frame constructed from 1-1/2" angle iron and 2" x 2" wire mesh
- Includes: Two rigid and two swivel 5" or 6" bolted-on casters
- Durable Kleton blue enamel finish
- Capacity is based on evenly distributed weight



M0060



M0045

WITHOUT DROP GATE

Model No	Caster Diameter	Caster Material	Dimensions W" x H" x D"	Capacity
M0044	5"	Rubber	24 x 55 x 36	1200 lbs.
M0046	6"	Polyurethane	24 x 55 x 36	2400 lbs.
M0048	5"	Rubber	24 x 55 x 48	1200 lbs.
M0050	6"	Polyurethane	24 x 55 x 48	2400 lbs.
M0052	5"	Rubber	24 x 55 x 60	1200 lbs.
M0054	6"	Polyurethane	24 x 55 x 60	2400 lbs.
M0056	5"	Rubber	30 x 55 x 48	1200 lbs.
M0058	6"	Polyurethane	30 x 55 x 48	2400 lbs.
M0060	5"	Rubber	30 x 55 x 60	1200 lbs.
M0062	6"	Polyurethane	30 x 55 x 60	2400 lbs.
M0064	5"	Rubber	30 x 55 x 72	1200 lbs.
M0066	6"	Polyurethane	30 x 55 x 72	2400 lbs.

WITH DROP GATE

Model No	Caster Diameter	Caster Material	Dimensions W" x H" x D"	Capacity
M0045	5"	Rubber	24 x 55 x 36	1200 lbs.
M0047	6"	Polyurethane	24 x 55 x 36	2400 lbs.
M0049	5"	Rubber	24 x 55 x 48	1200 lbs.
M0051	6"	Polyurethane	24 x 55 x 48	2400 lbs.
M0053	5"	Rubber	24 x 55 x 60	1200 lbs.
M0055	6"	Polyurethane	24 x 55 x 60	2400 lbs.
M0057	5"	Rubber	30 x 55 x 48	1200 lbs.
M0059	6"	Polyurethane	30 x 55 x 48	2400 lbs.
M0061	5"	Rubber	30 x 55 x 60	1200 lbs.
M0063	6"	Polyurethane	30 x 55 x 60	2400 lbs.
M0065	5"	Rubber	30 x 55 x 72	1200 lbs.
M0067	6"	Polyurethane	30 x 55 x 72	2400 lbs.

MESH STOCK TRUCKS

- Rugged all-welded steel construction, ready to use
- Designed for efficient loading/unloading and transportation of merchandise



ML163

TWO-SIDED WIRE MESH SHELF TRUCKS

- 14-gauge steel shelves, 1-1/2" lip up
- Frame constructed from 1-1/2" angle iron and 2" x 2" wire mesh
- Includes: Two rigid and two swivel 5" or 6" bolted-on casters
- Durable Kleton blue enamel finish
- Handle Height: 42"

1200 - 2400 LB. CAPACITY
Evenly Distributed

2 SHELVES

5" Non-Marking Rubber Casters 1200-lb. Cap. Model No.	6" Polyurethane Casters 2400-lb. Cap. Model No.	Base W" x L"	Inside Wall Height"	Clearance Between Shelves	Overall Dimensions W" x L" x H"	Wt. lbs.
ML162	ML168	24 x 36	55	26	24 x 39 x 63	95
ML163	ML169	24 x 48	55	26	24 x 51 x 63	112
ML164	ML170	24 x 60	55	26	24 x 63 x 63	127
ML165	ML171	30 x 48	55	26	30 x 51 x 63	129
ML166	ML172	30 x 60	55	26	30 x 63 x 63	144
ML167	ML173	30 x 72	55	26	30 x 75 x 63	167



ML175

3 SHELVES

5" Non-Marking Rubber Casters 1200-lb. Cap. Model No.	6" Polyurethane Casters 2400-lb. Cap. Model No.	Base W" x L"	Inside Wall Height"	Clearance Between Shelves"	Overall Dimensions W" x L" x H"	Wt. lbs.
ML174	ML180	24 x 36	55	16-1/2	24 x 39 x 63	120
ML175	ML181	24 x 48	55	16-1/2	24 x 51 x 63	137
ML176	ML182	24 x 60	55	16-1/2	24 x 63 x 63	152
ML177	ML183	30 x 48	55	16-1/2	30 x 51 x 63	154
ML178	ML184	30 x 60	55	16-1/2	30 x 63 x 63	169
ML179	ML185	30 x 72	55	16-1/2	30 x 75 x 63	192

REPLACEMENT PARTS

- Model No. **ML338**, 5" Rigid Non-Marking Rubber Caster
 Model No. **ML337**, 5" Swivel Non-Marking Rubber Caster
 Model No. **ML400**, 6" Rigid Polyurethane Caster
 Model No. **ML399**, 6" Swivel Polyurethane Caster

BOX TRUCKS



MB672

1200 - LB. CAPACITY
Evenly Distributed

- Rugged all-welded 1-1/2" angle iron construction and 2" x 2" wire mesh
- Contains and transports small bulk parts or materials in your plant or warehouse
- Includes: two rigid and two swivel 5" non-marking bolted-on rubber casters
- Durable Kleton blue enamel finish

Model No.	Base W" x L"	Inside Wall Height"	Handle Height"	Overall Dimensions W" x L" x H"	Wt. lbs.
MB672	24 x 36	24	30	24 x 39 x 31.5	62
ML186	24 x 48	24	30	24 x 51 x 31.5	75
ML187	24 x 60	24	30	24 x 63 x 31.5	85
ML188	30 x 48	24	30	30 x 51 x 31.5	86
MB680	30 x 60	24	30	30 x 63 x 31.5	95
ML189	30 x 72	24	30	30 x 75 x 31.5	107



- Rugged all-welded steel construction, ready to use
- Designed for efficient loading/unloading and transportation of merchandise

MESH STOCK TRUCKS

**1200 - 2400 LB.
CAPACITY**
Evenly Distributed

3-SIDED WIRE MESH SHELF TRUCKS

- 14-gauge steel shelves, 1-1/2" lip up
- Frame constructed from 1-1/2" angle iron and 2" x 2" wire mesh
- Includes: Two rigid and two swivel 5" or 6" bolted-on casters
- Durable Kleton blue enamel finish
- Handle Height: 42"

1 SHELF

5" Non-Marking Rubber Casters 1200-lb. Cap. Model No.	6" Polyurethane Casters 2400-lb. Cap. Model No.	Base W" x L"	Inside Wall Height"	Overall Dimensions W" x L" x H"	Wt. lbs.
ML220	ML190	24 x 36	55	24 x 39 x 63	102
ML221	ML191	24 x 48	55	24 x 51 x 63	110
ML222	ML192	24 x 60	55	24 x 63 x 63	120
ML223	ML193	30 x 48	55	30 x 51 x 63	135
ML224	ML194	30 x 60	55	30 x 63 x 63	145
ML225	ML195	30 x 72	55	30 x 75 x 63	155



ML221

2 SHELVES

5" Non-Marking Rubber Casters 1200-lb. Cap. Model No.	6" Polyurethane Casters 2400-lb. Cap. Model No.	Base W" x L"	Inside Wall Height"	Clearance Between Shelves"	Overall Dimensions W" x L" x H"	Wt. lbs.
ML196	ML202	24 x 36	55	26	24 x 39 x 63	127
ML197	ML203	24 x 48	55	26	24 x 51 x 63	142
ML198	ML204	24 x 60	55	26	24 x 63 x 63	159
ML199	ML205	30 x 48	55	26	30 x 51 x 63	182
ML200	ML206	30 x 60	55	26	30 x 63 x 63	192
ML201	ML207	30 x 72	55	26	30 x 75 x 63	211



ML200

3 SHELVES

5" Non-Marking Rubber Casters 1200-lb. Cap. Model No.	6" Polyurethane Casters 2400-lb. Cap. Model No.	Base W" x L"	Inside Wall Height"	Clearance Between Shelves"	Overall Dimensions W" x L" x H"	Wt. lbs.
ML208	ML214	24 x 36	55	16-1/2	24 x 39 x 63	152
ML209	ML215	24 x 48	55	16-1/2	24 x 51 x 63	174
ML210	ML216	24 x 60	55	16-1/2	24 x 63 x 63	198
ML211	ML217	30 x 48	55	16-1/2	30 x 51 x 63	229
ML212	ML218	30 x 60	55	16-1/2	30 x 63 x 63	239
ML213	ML219	30 x 72	55	16-1/2	30 x 75 x 63	267



ML209

REPLACEMENT PARTS

- Model No. **ML338**, 5" Rigid Non-Marking Rubber Caster
- Model No. **ML337**, 5" Swivel Non-Marking Rubber Caster
- Model No. **ML400**, 6" Rigid Polyurethane Caster
- Model No. **ML399**, 6" Swivel Polyurethane Caster

SECURITY TRUCKS

Customize KLETON
products to your specs!
See Inside Front Cover



ML242

- 14 gauge steel shelves, 1-1/2" lip up
- Frame constructed from 1-1/2" angle iron and 2" x 2" wire mesh
- Includes: Two rigid and two swivel 5" or 6" bolted-on casters
- Comes with hasp for padlock
- Durable KLETON blue enamel finish
- Handle height: 42"

**1200 - 2400 LB.
CAPACITY**
Evenly Distributed

2 SHELVES

5" Non-Marking Rubber Casters 1200-lb. Cap. Model No.	6" Polyurethane Casters 2400-lb. Cap. Model No.	Base W" x L"	Inside Wall Height"	Clearance Between Shelves"	Overall Dimensions W" x L" x H"	Wt. lbs.
ML238	ML244	24 x 36	55	25	26 x 39 x 62.5	157
ML239	ML245	24 x 48	55	25	26 x 51 x 62.5	172
ML240	ML246	24 x 60	55	25	26 x 63 x 62.5	189
ML241	ML247	30 x 48	55	25	32 x 51 x 62.5	212
ML242	ML248	30 x 60	55	25	32 x 63 x 62.5	222
ML243	ML249	30 x 72	55	25	32 x 75 x 62.5	241



ML254

3 SHELVES

5" Non-Marking Rubber Casters 1200-lb. Cap. Model No.	6" Polyurethane Casters 2400-lb. Cap. Model No.	Base W" x L"	Inside Wall Height"	Clearance Between Shelves"	Overall Dimensions W" x L" x H"	Wt. lbs.
ML250	ML256	24 x 36	55	16	26 x 39 x 62.5	182
ML251	ML257	24 x 48	55	16	26 x 51 x 62.5	204
ML252	ML258	24 x 60	55	16	26 x 63 x 62.5	228
ML253	ML259	30 x 48	55	16	32 x 51 x 62.5	259
ML254	ML260	30 x 60	55	16	32 x 63 x 62.5	269
ML255	ML261	30 x 72	55	16	32 x 75 x 62.5	297

REPLACEMENT PARTS

- Model No. **ML338**, 5" Rigid Non-Marking Rubber Caster
 Model No. **ML337**, 5" Swivel Non-Marking Rubber Caster
 Model No. **ML400**, 6" Rigid Polyurethane Caster
 Model No. **ML399**, 6" Swivel Polyurethane Caster

ENCLOSED WIRE STOCK PICKING CARTS

- High quality chromate shelves and posts prevent corrosion
- Enclosed sides keeps items from falling out
- Shelves can be adjusted quickly and easily
- Includes: (2) 5" swivel resilient casters, (2) 5" rubber caster with brakes
- Shipped knocked down
- One-year limited warranty
- Capacity is based on evenly distributed weight
- No. of Shelves: 4 • Strong and versatile
- Cart Material: Chrome Plated • NSF Certified

800 LB. CAPACITY
Evenly Distributed

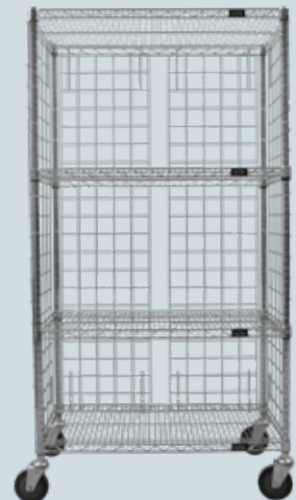

Model No.	Overall Width"	Overall Height"	Overall Depth"
RN559	18	69	36
RN560	18	69	48
RN561	18	69	36
RN562	24	69	36
RN563	24	69	48
RN564	24	69	60

WIRE ENCLOSURE PANELS

Model No.	Dimensions W" x H"
RN556	15 x 61.5
RN557	18 x 61.5
RN558	21 x 61.5



Customize KLETON products to your specs!
See Inside Front Cover

ALL-WELDED SHELF TRUCKS

1200 LB. CAPACITY
Evenly Distributed

1" round tube handle for added comfort

Double-fold 1-1/2" lip for safety and added strength configured up or down

All-welded 14-gauge steel for extra strength. Welded to 1-1/2" x 12-1/2" x 1/8" steel angle posts.

Two rigid and two swivel 5" non-marking double raceway casters for easy manoeuvrability with heavy loads

Sealed bearings for longer life

Durable KLETON blue enamel finish



ML092



MB476

Lip Up Model No.	Lip Down Model No.	Shelf Size W" x D"	No. of Shelves	Clearance Between Shelves"	Handle Height"	Overall Dim. W" x D" x H"	Wt. lbs.
36" OVERALL HEIGHT - 14 GAUGE STEEL							
MB445	MB444	18 x 30	2	27	36	18 x 33 x 36	60
MB447	MB446	24 x 36	2	27	36	24 x 39 x 36	65
MB449	MB448	24 x 48	2	27	36	24 x 51 x 36	100
MB456	MB455	18 x 30	3	12	36	18 x 33 x 36	75
MB459	MB458	24 x 36	3	12	36	24 x 39 x 36	85
MB461	MB460	24 x 48	3	12	36	24 x 51 x 36	110
48" OVERALL HEIGHT - 14 GAUGE STEEL							
ML084	ML083	18 x 30	3	18	42	18 x 33 x 48	80
ML086	ML085	24 x 36	3	18	42	24 x 39 x 48	90
ML088	ML087	24 x 48	3	18	42	24 x 51 x 48	115
ML090	ML089	18 x 30	4	12	42	18 x 33 x 48	110
ML092	ML091	24 x 36	4	12	42	24 x 39 x 48	135
ML094	ML093	24 x 48	4	12	42	24 x 51 x 48	160
61" OVERALL HEIGHT - 14 GAUGE STEEL							
MB468	MB467	18 x 30	4	16	42	18 x 33 x 61	115
MB470	MB469	24 x 36	4	16	42	24 x 39 x 61	140
MB472	MB471	24 x 48	4	16	42	24 x 51 x 61	165
MB474	MB473	18 x 30	5	11	42	18 x 33 x 61	125
MB476	MB475	24 x 36	5	11	42	24 x 39 x 61	155
MB478	MB477	24 x 48	5	11	42	24 x 51 x 61	184

CUSTOM OPTIONS

- Model No. **ML337**, 5" Swivel Non-Marking Rubber Caster
- Model No. **ML338**, 5" Rigid Non-Marking Rubber Caster
- Model No. **MN222**, 8" Swivel Pneumatic Caster
- Model No. **MN221**, 8" Rigid Pneumatic Caster
- Model No. **ML395**, 5" Swivel Polyolefin Caster
- Model No. **ML396**, 5" Rigid Polyolefin Caster
- Model No. **MC043**, Corner Bumper



MC043



ML337



ML338



ML627



ML626



ML395



ML396

KNOCKED-DOWN SHELF TRUCKS

Customize KLETON products to your specs!
See Inside Front Cover



CHOOSE FROM 3 CASTER TYPES



900 - LB. CAPACITY
Evenly Distributed



5" POLYOLEFIN



5" BLUE ELASTIC RUBBER



8" PNEUMATIC

Seamed fold for smooth edges

Durable KLETON blue enamel finish

Top and middle shelves can be installed lip up or down

Slotted caster holes to allow virtually any caster to be installed



1-1/4" diameter tubular steel, one piece handle for added comfort

16-gauge steel shelves with 2-1/2" high lip

1-1/2" x 1-1/2" 12-gauge steel posts with pre-punched holes for added strength

2 rigid and 2 swivel bolted-on casters



MB489



MB496

2 SHELF UTILITY TRUCKS

Model No.	Shelf Dimensions W" x D"	Shelf Clearance"	Post Height"	Overall Dim W" x D" x H"	Weight lbs.
-----------	--------------------------	------------------	--------------	--------------------------	-------------

5" POLYOLEFIN CASTERS

MB482	18 x 30	25	30	18 x 33 x 36	42
MB483	24 x 36	25	30	24 x 39 x 36	53
MB484	24 x 48	25	30	24 x 51 x 36	68

5" BLUE ELASTIC RUBBER CASTERS

MB492	18 x 30	25	30	18 x 33 x 36	43
MB493	24 x 36	25	30	24 x 39 x 36	54
MB494	24 x 48	25	30	24 x 51 x 36	69

8" PNEUMATIC CASTERS

MB488	24 x 36	25	30	24 x 39 x 40	60
MB489	24 x 48	25	30	24 x 51 x 40	75

3 SHELF UTILITY TRUCKS

Model No.	Shelf Dimensions W" x D"	Shelf Clearance"	Post Height"	Overall Dim W" x D" x H"	Weight lbs.
-----------	--------------------------	------------------	--------------	--------------------------	-------------

5" POLYOLEFIN CASTERS

MB485	18 x 30	11	30	18 x 33 x 36	53
MB486	24 x 36	11	30	24 x 39 x 36	69
MB487	24 x 48	11	30	24 x 51 x 36	92
MN143	18 x 30	17	42	18 x 33 x 48	55
MN144	24 x 36	17	42	24 x 39 x 48	71
MN145	24 x 48	17	42	24 x 51 x 48	94

5" BLUE ELASTIC RUBBER CASTERS

MB495	18 x 30	11	30	18 x 33 x 36	54
MB496	24 x 36	11	30	24 x 39 x 36	70
MB497	24 x 48	11	30	24 x 51 x 36	93
ML142	18 x 30	17	42	18 x 33 x 48	56
ML143	24 x 36	17	42	24 x 39 x 48	72
ML144	24 x 48	17	42	24 x 51 x 48	95

8" PNEUMATIC CASTERS

MB490	24 x 36	11	30	24 x 39 x 40	77
MB491	24 x 48	11	30	24 x 51 x 40	100
MN146	24 x 36	17	42	24 x 39 x 52	79
MN147	24 x 48	17	42	24 x 51 x 52	102



Customize KLETON
products to your specs!
See Inside Front Cover

KNOCKED-DOWN SHELF TRUCKS

4 SHELF UTILITY TRUCKS

Model No.	Shelf Dimensions W" x D"	Shelf Clearance"	Post Height"	Overall Dim W" x D" x H"	Weight lbs.
5" POLYOLEFIN CASTERS					
MN148	18 x 30	10	42	18 x 33 x 48	65
MN149	24 x 36	10	42	24 x 39 x 48	84
MN150	24 x 48	10	42	24 x 51 x 48	114
MN151	18 x 30	15	55	18 x 33 x 61	67
MN152	24 x 36	15	55	24 x 39 x 61	86
MN153	24 x 48	15	55	24 x 51 x 61	116

5" BLUE ELASTIC RUBBER CASTERS

ML145	18 x 30	10	42	18 x 33 x 48	66
ML146	24 x 36	10	42	24 x 39 x 48	85
ML147	24 x 48	10	42	24 x 51 x 48	115
ML148	18 x 30	15	55	18 x 33 x 61	68
ML149	24 x 36	15	55	24 x 39 x 61	87
ML150	24 x 48	15	55	24 x 51 x 61	117

8" PNEUMATIC CASTERS

MN154	24 x 36	10	42	24 x 39 x 52	90
MN155	24 x 48	10	42	24 x 51 x 52	120
MN156	24 x 36	15	55	24 x 39 x 65	92
MN157	24 x 48	15	55	24 x 51 x 65	122

5 SHELF UTILITY TRUCKS

Model No.	Shelf Dimensions W" x D"	Shelf Clearance"	Post Height"	Overall Dim W" x D" x H"	Weight lbs.
5" POLYOLEFIN CASTERS					
MN158	18 x 30	10	55	18 x 33 x 61	79
MN159	24 x 36	10	55	24 x 39 x 61	99
MN160	24 x 48	10	55	24 x 51 x 61	134

5" BLUE ELASTIC RUBBER CASTERS

ML151	18 x 30	10	55	18 x 33 x 61	80
ML152	24 x 36	10	55	24 x 39 x 61	100
ML153	24 x 48	10	55	24 x 51 x 61	135

8" PNEUMATIC CASTERS

MN161	24 x 36	10	55	24 x 39 x 65	105
MN162	24 x 48	10	55	24 x 51 x 65	140



ML146



ML152

CUSTOM OPTIONS

- Model No. **ML337**, 5" Swivel Non-Marking Rubber Caster
- Model No. **ML338**, 5" Rigid Non-Marking Rubber Caster
- Model No. **MN222**, 8" Swivel Pneumatic Caster
- Model No. **MN221**, 8" Rigid Pneumatic Caster
- Model No. **ML395**, 5" Swivel Polyolefin Caster
- Model No. **ML396**, 5" Rigid Polyolefin Caster
- Model No. **MC043**, Corner Bumper



MC043



ML337



ML338



ML627



ML626



ML395



ML396

LOW PROFILE SHELF TRUCKS



- All-welded cart with low shelf means less distance to lift heavy object
- Two 14-gauge steel shelves with a = 1-1/2" lip down
- 1-1/4" diameter tubular steel handle
- 2 rigid and 2 swivel bolted-on casters
- Durable KLETON blue enamel finish

1200 - LB. CAPACITY
Evenly Distributed



MB425

HEAVY-DUTY LOW PROFILE SHOP TRUCKS 5" RUBBER CASTERS

- Non-marking 5" rubber casters are quiet rolling and ideal for both institutional and industrial applications
- Casters are resistant to wet and corrosive chemical conditions

Model No.	Shelf Size"	Clearance Between Shelves"	Handle Height"	Top Shelf Height"	Overall Dimensions W" x L" x H"	Wt. lbs.
MB421	18 x 30	16	40	26	18 x 34 x 40	90
MB425	24 x 36	16	40	26	24 x 40 x 40	110
MB429	24 x 48	16	40	26	24 x 52 x 40	125
ML097	24 x 60	16	40	26	24 x 64 x 40	155
ML098	30 x 48	16	40	26	30 x 52 x 40	155
MB434	30 x 60	16	40	26	30 x 64 x 40	165
ML099	30 x 72	16	40	26	30 x 76 x 40	175

REPLACEMENT PARTS

Model No. **ML338**, 5" Rigid Non-Marking Rubber Caster
 Model No. **ML337**, 5" Swivel Non-Marking Rubber Caster
 Model No. **MC043**, Corner Bumpers

2400 - LB. CAPACITY
Evenly Distributed



MB426

HEAVY-DUTY LOW PROFILE SHOP TRUCKS 6" HIGH TEMP OR POLYURETHAN CASTERS

- Solid black 6" high-temp nylon casters handle heavy loads easily
- Solid 6" polyurethane casters are non-marking and are highly resistant to wear
- Best choice in uneven floor applications
- Handle height: 41"

6" HIGH-TEMP NYLON CASTERS

Model No.	Shelf Size"	Clearance Between Shelves"	Top Shelf Height"	Overall Dim. W" x L" x H"	Wt. lbs.
MB422	18 x 30	16	27	18 x 34 x 41	100
MB426	24 x 36	16	27	24 x 40 x 41	130
MB430	24 x 48	16	27	24 x 52 x 41	145
ML100	24 x 60	16	27	24 x 64 x 41	155
ML101	30 x 48	16	27	30 x 52 x 41	155
MB435	30 x 60	16	27	30 x 64 x 41	165
ML102	30 x 72	16	27	30 x 76 x 41	175

6" POLYURETHANE CASTERS

Model No.	Shelf Size"	Clearance Between Shelves"	Top Shelf Height"	Overall Dim. W" x L" x H"	Wt. lbs.
ML103	18 x 30	16	27	18 x 34 x 41	100
ML104	24 x 36	16	27	24 x 40 x 41	130
ML105	24 x 48	16	27	24 x 52 x 41	145
ML106	24 x 60	16	27	24 x 64 x 41	155
ML107	30 x 48	16	27	30 x 52 x 41	155
ML108	30 x 60	16	27	30 x 64 x 41	165
ML109	30 x 72	16	27	30 x 76 x 41	175

REPLACEMENT PARTS

Model No. **ML400**, 6" Rigid Polyurethane Caster
 Model No. **ML399**, 6" Swivel Polyurethane Caster
 Model No. **ML862**, 6" Rigid Hi-Temp Nylon Caster
 Model No. **ML861**, 6" Swivel Hi-Temp Nylon Caster
 Model No. **MC043**, Corner Bumpers



Customize KLETON
products to your specs!
See Inside Front Cover

SHELF TRUCKS & STOCK PICKING TRUCKS

SHELF/PLATFORM TRUCKS

- An efficient 2-in-1 shelf and platform truck design
- Features 2 front corner bumpers and a removable 11-gauge top shelf to convert to a platform truck
- 2 rigid and 2 swivel bolted-on 5" non-marking rubber casters
- Top shelf capacity: 500 lbs. evenly distributed
- Bottom shelf capacity: 800 lbs. evenly distributed
- Durable Kleton blue enamel finish

1300 - LB. CAPACITY
Evenly Distributed



Model No.	Shelf Size"	Top Shelf Height"	Shelf Clearance"	Handle Height"	Overall Dim. W" x L" x H"	Wt. lbs.
MB391	24 x 36	32	24	40	26 x 38 x 40	105

REPLACEMENT PARTS

- Model No. **ML338**, 5" Rigid Non-Marking Rubber Caster
 Model No. **ML337**, 5" Swivel Non-Marking Rubber Caster
 Model No. **MC043**, Corner Bumpers

STOCK PICKING TRUCKS

- Pick and transport stock without the need for a separate ladder
- Slip-resistant 22" W x 4" D steps and positive locking engagement for safety
- 14-gauge steel shelves with 1-1/2" lip, configured up
- 1-1/2" x 1-1/2" x 1/8" steel angle posts
- 2 rigid and 2 swivel bolted-on non-marking rubber casters

1200 - LB. CAPACITY
Evenly Distributed



Model No.	Shelf Size"	Number of Shelves	Clearance Between Shelves"	Number of Steps	Step Rise"	Overall Dimensions W" x L" x H"	Wt. lbs.
MD441	24 x 36	3	12	3	9-1/2	24 x 52 x 61	135
MB507	24 x 48	3	12	3	9-1/2	24 x 64 x 61	140
MD442	24 x 36	3	12	5	9-1/2	24 x 52 x 78	145
MB508	24 x 48	3	12	5	9-1/2	24 x 64 x 78	150

ORDER PICKING TRUCKS

- Picking list holder eliminates the need to handle loose papers
- 14-gauge steel shelves with 1-1/2" lip, configured up
- 1-1/2" x 1-1/2" x 1/8" steel angle posts
- 2 rigid and 2 swivel bolted 5" non-marking rubber casters

1200 - LB. CAPACITY
Evenly Distributed



Model No.	Shelf Size"	Number of Shelves	Clearance Between Shelves"	Handle Height"	Overall Dimensions W" x L" x H"	Wt. lbs.
MB440	18 x 30	2	27	36	18 x 46 x 36	70
MB441	24 x 36	2	27	36	24 x 52 x 36	80
ML095	24 x 48	2	27	36	24 x 64 x 36	110
MB442	18 x 30	3	12	36	18 x 46 x 36	85
MB443	24 x 36	3	12	36	24 x 52 x 36	100
ML096	24 x 48	3	12	36	24 x 64 x 36	120

SHELF TRUCKS & MOBILE SERVICE TRUCKS

Customize KLETON products to your specs!
See Inside Front Cover



1200 - LB. CAPACITY
Evenly Distributed



MH255

HEAVY-DUTY SHELF TRUCKS WITH DRAWER

- Cart constructed from 14-gauge steel shelves welded to 1-1/2" x 1-1/2" x 1/8" steel angle posts
- 36" high, 1" diameter tubular steel handle
- Drawer dimensions: 15 1/4" W x 20" L x 6" H, 100-lb. capacity
- Available in models with 2 or 3 shelves with 1-1/2" lip configured up
- 2 rigid and 2 swivel bolted-on 5" non-marking casters

Model No.	Shelf Size"	No. Shelves	Clearance Between Shelves"	Drawer to Shelf Clearance"	Overall Dimensions W" x L" x H"	Wt. lbs.
MH255	24 x 36	2	27	18	24 x 39 x 36	75
MH256	24 x 36	3	12	3	24 x 39 x 36	95
ML081	24 x 48	2	27	18	24 x 51 x 36	110
ML082	24 x 48	3	12	3	24 x 51 x 36	120

REPLACEMENT PARTS

- Model No. **ML338**, 5" Rigid Non-Marking Rubber Caster
 Model No. **ML337**, 5" Swivel Non-Marking Rubber Caster
 Model No. **MC043**, Corner Bumpers

MOBILE SERVICE TRUCK

- Louvered panel for small parts bins and lockable drawer for supplies
- Two 14-gauge steel shelves welded to 1-1/2" x 1-1/2" x 1/8" steel posts
- 36" high, 1" diameter tubular handle
- 2 rigid and 2 swivel with brake bolted-on 5" non-marking rubber casters



1200 - LB. CAPACITY
Evenly Distributed

Model No.	Shelf Size"	No. Shelves	Clearance Between Shelves"	Drawer to Shelf Clearance"	Overall Dimensions W" x L" x H"	Wt. lbs.
MN396	24 x 36	2	27	18	24 x 40 x 37	88

MOBILE SERVICE CARTS

1200 - LB. CAPACITY
Evenly Distributed

- All welded design, ready to use
- Two 14 gauge steel shelves welded to 1 1/2" x 1 1/2" x 1/8" steel posts 1" diameter tubular handle
- Two rigid and two swivel with brake bolted-on 5" non-marking rubber casters
- Durable Kleton blue enamel finish



MP084



MP085

Model No.	No. Shelves	Overall Dimensions W" x L" x H"	Description
MP084	2	24 x 40 x 57	Pegboard
MP085	2	24 x 40 x 57	Louvered/Pegboard



Customize KLETON
products to your specs!
See Inside Front Cover

ERGONOMIC SHELF & PLATFORM TRUCKS

DEEP LIPPED SERVICE TRUCKS

- All welded design, ready to use
- Deep shelf lips for retention
- Two 14 gauge steel shelves welded to 1-1/2" x 1-1/2" x 1/8" steel posts
- 1" diameter tubular ergonomic handle
- Two rigid and two swivel 5" non-marking rubber casters
- Durable KLETON blue enamel finish

Model No.	Shelf Size W" x D"	Shelf Lip Depth	Clearance Between Shelves "	Overall Dimensions W" x D" x H"	Wt. lbs.
MN393	24 x 36	Top 6"/Bottom 1-1/2"	22-1/2	24 x 42 x 47	85
MN394	24 x 36	Top 12"/Bottom 1-1/2"	16	24 x 42 x 47	90
MN395	24 x 36	Top 6"/Bottom 6"	18	24 x 42 x 47	90

MN395



1200 - LB. CAPACITY
Evenly Distributed

ERGONOMIC SHELF TRUCKS

- All-welded 16-gauge construction
- All-welded ergonomic handle placed at a comfortable working height
- Two rigid and two swivel 5" casters
- Durable KLETON blue enamel finish



800 - LB. CAPACITY
Evenly Distributed

Model No.	Number of Shelves	Caster Type	Overall Dimensions W" x D" x H"	Wt. lbs.
ML561	2	Blue Rubber	20 x 32 x 37	53
MN056	2	Blue Rubber	26 x 38 x 37	67
ML562	3	Blue Rubber	20 x 32 x 37	65
MN055	3	Blue Rubber	26 x 38 x 37	93
ML563	2	Polyolefin	20 x 32 x 37	49
ML883	2	Polyolefin	26 x 38 x 37	63
ML564	3	Polyolefin	20 x 32 x 37	61
ML884	3	Polyolefin	26 x 38 x 37	89

REPLACEMENT PARTS

- Model No. **ML338**, 5" Rigid Non-Marking Rubber Caster
- Model No. **ML337**, 5" Swivel Non-Marking Rubber Caster
- Model No. **ML396**, 5" Rigid Polyolefin Caster
- Model No. **ML395**, 5" Swivel Polyolefin Caster

ERGONOMIC PLATFORM TRUCK

- Ergonomic handle is placed at a comfortable working height to alleviate back strains
- Picking list holder eliminates the need to handle loose papers
- Deck is constructed from 14-gauge all welded steel with a turned down lip and reinforced channels
- Two rigid and two swivel casters 8" mold-on rubber casters
- Dimensions: 48"L x 24"W
- Weight: 90 lbs.
- KLETON powder coat finish

Model No. **ML892**



1200 - LB. CAPACITY
Evenly Distributed

REPLACEMENT PARTS

- Model No. **ML853**, 8" Rigid Mold-On Rubber
- Model No. **ML852**, 8" Swivel Mold-On Rubber

PLASTIC SHELF TRUCKS & PLATFORM TRUCKS

PLASTIC UTILITY SERVICE TRUCKS

- Durable structural foam construction will not dent, rust or bend
- Non-marking 5" casters
- Overall dimensions: 17-1/2" W x 34-1/2" D x 32-1/2" H

Model No. **ML618**

- Durable structural foam construction will not dent, rust or bend
- Non-marking 5" casters
- Overall dimensions: 25-1/2" W x 40-1/2" D x 32-1/2" H

Model No. **ML619**

**300 - LB.
CAPACITY**

Evenly Distributed

PLASTIC FLAT SHELF UTILITY TRUCKS

- Durable structural foam construction will not dent, rust or bend
- Non-marking 5" casters
- Flat top shelf makes loading and unloading of heavy boxes easy
- Overall dimensions: 25-1/2" W x 40-1/2" D x 32-1/2" H

Model No. **ML620**



ML618



ML619



ML620

REPLACEMENT PARTS - COMPATIBLE WITH THREE MODELS ABOVE

Model No. **MO730**, 5" Rigid Non-marking Rubber Caster

Model No. **MO731**, 5" Swivel Non-marking Rubber Caster

**900 - 2500 - LB.
CAPACITY**

Evenly Distributed



MN428

PLASTIC PLATFORM TRUCKS

- HDPE-molded structural plastic for strength and long-term durability
- Lightweight, easy to clean, chemical resistant, and resists damage from long-term exposure to weather conditions
- Non-skid deck surface
- Removable steel handle
- Other caster options and capacities available upon request

Model No.	Caster Type	Platform Size W" x L"	Deck Height"	Handle Height"	Cap. lbs.	Wt. lbs.
MN428	8" Mold-on Rubber	24 x 48	11	39	2000	90
MN429	8" Mold-on Rubber	30 x 60	11	39	2000	117
MN430	8" Polyurethane	24 x 48	11	39	2500	79
MN431	8" Polyurethane	30 x 60	11	39	2500	106
MN432	10" Pneumatic	24 x 48	13	41	1200	84
MN433	10" Pneumatic	30 x 60	13	41	1200	111
MN434	10" Flat-Free	24 x 48	13	41	1000	85
MN435	10" Flat-Free	30 x 60	13	41	1000	117
MN436	8" Pneumatic	24 x 48	11	39	1000	79
MN437	8" Pneumatic	30 x 60	11	39	1000	106
MN438	8" Flat-Free	24 x 48	11	39	900	80
MN439	8" Flat-Free	30 x 60	11	39	900	107

UTILITY CARTS & TROLLEYS

UTILITY CARTS

- Shelf design allows for quick and easy loading
- Light and easy to maneuver
- No. of Shelves: 3
- Cart Material: Plastic
- Wheel Material: Rubber
- Capacity: 250 lbs.
- Assembly required



TROLLEY

- Durable construction resistant to chipping and peeling
- Three convenient handle positions: up, 45° angle and folded down
- 5" rubber casters are resistant to marking
- Deck Width: 20-1/2"
- Deck Length: 31-3/4"
- Deck Height: 6"
- Handle Height: 27"
- Capacity: 500 lbs.
- Deck Material: Plastic

Model No. JH489



Model No.	Overall Width"	Overall Depth"	Overall Height"
JH486	19-3/4	37-1/2	40-1/4
JH487	16-3/4	33-1/2	37

WIRE MESH OFFICE MAIL CART

- Ideal for carrying hanging folders, packages and office supplies
- Comes with three wire dividers and two removable baskets
- Shipped knocked down
- Capacity: 250 lbs.
- Overall Depth: 23"
- Overall Length: 42"
- Overall Height: 38"
- Cart Material: Chrome Plated
- No. of Shelves: 2
- No. of Baskets: 2

Model No. M0843



STEEL DECK PLATFORM TRUCKS

- All-welded design 14-gauge steel base
- 2" turned down lip and reinforced channels underneath
- Double welded sockets
- Removable 1-1/4" chrome handle can be inserted in either end
- Two swivel and two rigid bolted-on casters
- Kleton blue powder coat finish
- Shipped knocked-down



MB246

**900 - LB.
CAPACITY**

Evenly Distributed

Plastic wheel with high impact strength and non-chipping properties. Resistant to oil, grease, and most chemicals.

STEEL DECKS - 5" POLYOLEFIN CASTERS

Model No.	Platform Size			Deck Height"	Handle Height"	Wt. lbs.
	W"	x	L"			
MB238	24	x	36	8	36	61
MB246	24	x	48	8	36	74
MD427	30	x	48	8	36	80
MB254	30	x	60	8	36	94

REPLACEMENT PARTS

- Model No. **ML396**, 5" Rigid Polyolefin Caster
 Model No. **ML337**, 5" Swivel Polyolefin Caster
 Model No. **MB218**, 24" Chrome Handle
 Model No. **MB221**, 30" Chrome Handle



MB237

**1200 - LB.
CAPACITY**

Evenly Distributed

Great for uneven surfaces and carpeted areas. Quiet rolling casters make it ideal for institutional and industrial applications. Resists wet and corrosive chemical environments.

STEEL DECKS - 5" NON-MARKING RUBBER CASTERS

Model No.	Platform Size			Deck Height"	Handle Height"	Wt. lbs.
	W"	x	L"			
MB237	24	x	36	8	36	63
MB245	24	x	48	8	36	76
MD426	30	x	48	8	36	82
MB253	30	x	60	8	36	96

REPLACEMENT PARTS

- Model No. **ML338**, 5" Rigid Non-Marking Rubber Caster
 Model No. **ML337**, 5" Swivel Non-Marking Rubber Caster
 Model No. **MB218**, 24" Chrome Handle
 Model No. **MB221**, 30" Chrome Handle



MB240

**1300 - LB.
CAPACITY**

Evenly Distributed

Solid black hi-temp nylon caster will not crush under heavy loads. It is good for use on all sorts of surfaces from wood to concrete. Will tolerate temperatures from -28°C to 230°C and is not affected by most corrosive chemicals.

STEEL DECKS - 6" HI-TEMP NYLON CASTERS

Model No.	Platform Size			Deck Height"	Handle Height"	Wt. lbs.
	W"	x	L"			
MB232	24	x	36	9	37	77
MB240	24	x	48	9	37	90
MD421	30	x	48	9	37	96
MB248	30	x	60	9	37	110

REPLACEMENT PARTS

- Model No. **ML862**, 6" Rigid Hi-Temp Nylon Caster
 Model No. **ML861**, 6" Swivel Hi-Temp Nylon Caster
 Model No. **MB218**, 24" Chrome Handle
 Model No. **MB221**, 30" Chrome Handle



- All-welded design 14-gauge steel base
- 2" turned down lip and reinforced channels underneath
- Double welded sockets
- Removable 1-1/4" chrome handle can be inserted in either end
 - Two swivel and two rigid bolted-on casters
 - Kleton blue powder coat finish
 - Shipped knocked-down

STEEL DECK PLATFORM TRUCKS

STEEL DECKS - 8" HI-TEMP NYLON CASTERS

Model No.	Platform Size			Deck Height"	Handle Height"	Wt lbs.
	W"	x	L"			
MB233	24	x	36	11	39	87
MB241	24	x	48	11	39	100
MD422	30	x	48	11	39	106
MB249	30	x	60	11	39	120

REPLACEMENT PARTS

- Model No. **ML865**, 8" Rigid Hi-Temp Nylon Caster
 Model No. **ML864**, 8" Swivel Hi-Temp Nylon Caster
 Model No. **MB218**, 24" Chrome Handle
 Model No. **MB221**, 30" Chrome Handle

1400 - LB. CAPACITY

Evenly Distributed



Solid black hi-temp nylon caster will not crush under heavy loads. It is good for use on all sorts of surfaces from wood to concrete. Will tolerate temperatures from -28°C to 230°C and is not affected by most corrosive chemicals.



MB241

STEEL DECKS - 8" MOLD-ON RUBBER CASTERS

Model No.	Platform Size			Deck Height"	Handle Height"	Wt lbs.
	W"	x	L"			
MB236	24	x	36	11	39	96
MB244	24	x	48	11	39	109
MD425	30	x	48	11	39	115
MB252	30	x	60	11	39	129

REPLACEMENT PARTS

- Model No. **ML853**, 8" Rigid Mold-On Rubber Caster
 Model No. **ML852**, 8" Swivel Mold-On Rubber Caster
 Model No. **MB218**, 24" Chrome Handle
 Model No. **MB221**, 30" Chrome Handle

1400 - LB. CAPACITY

Evenly Distributed

Molded rubber wheel bonded to a cast iron core. Iron core gives this caster strength while the rubber provides smooth and quiet rolling over multiple types of surfaces.



MB244

STEEL DECKS - 8" FULL PNEUMATIC CASTERS

Model No.	Platform Size			Deck Height"	Handle Height"	Wt lbs.
	W"	x	L"			
MB234	24	x	36	11	39	79
MB242	24	x	48	11	39	92
MD423	30	x	48	11	39	98
MB250	30	x	60	11	39	112

REPLACEMENT PARTS

- Model No. **MN221**, 8" Rigid Pneumatic Caster
 Model No. **MN222**, 8" Swivel Pneumatic Caster
 Model No. **MB218**, 24" Chrome Handle
 Model No. **MB221**, 30" Chrome Handle

1000 - LB. CAPACITY

Evenly Distributed

Air filled black rubber tire offers excellent shock absorbing properties. Smooth, quiet rolling over rough terrain and uneven surfaces. Not recommended for floors with corrosive chemicals or sharp objects.



MB242

HEAVY-DUTY PLATFORM TRUCKS

- Steel deck made of a heavy-duty all-welded 11-gauge steel with reinforced channel formed deck
- Wood deck features a sturdy 2" x 2" angle iron frame with quality hardwood decking
- Removable 1-1/4" chrome handle can be placed at either end
- Two rigid and two swivel bolted-on casters



**2000 - LB.
CAPACITY**
Evenly Distributed

PLATFORM TRUCKS - 8" MOLD-ON RUBBER CASTERS

Molded rubber casters bonded to cast iron core. Iron core gives increased caster strength while the rubber provides smooth and quiet rolling over multiple types of surfaces.



MB295



MB296

STEEL DECK

Platform Size"	Deck Height"	Handle Height"	Wt. lbs.	Standard Corner	Diamond Tilt
24 x 48	11	40	110	MB295	MB297
30 x 48	11	40	130	MB303	MD331
30 x 60	11	40	140	MB307	MB309
36 x 72	11	40	175	MB319	MB321
48 x 96	11	40	240	MB323	MB325

WOOD DECK

Platform Size"	Deck Height"	Handle Height"	Wt. lbs.	Standard Corner	Diamond Tilt
24 x 48	11	40	110	MB296	MB298
30 x 48	11	40	130	MB304	MB306
30 x 60	11	40	140	MB308	MD332
36 x 72	11	40	175	MB320	MB322
48 x 96	11	40	240	MB324	MB326



**2500 - LB.
CAPACITY**
Evenly Distributed

PLATFORM TRUCKS - 8" HI-TEMP NYLON CASTERS

Solid black hi-temp nylon casters will not rush under heavy loads. Good for use on all sorts of surfaces from wood to concrete. Will tolerate temperatures from -28°C to 230°C and is not affected by most corrosive chemicals



MB143



MB130

STEEL DECK

Platform Size"	Deck Height"	Handle Height"	Wt. lbs.	Standard Corner	Diamond Tilt
24 x 48	11	40	110	MB131	MB132
30 x 48	11	40	130	MB139	MB140
30 x 60	11	40	140	MB143	MB144
36 x 72	11	40	175	MB154	MB156
48 x 96	11	40	240	MB167	MB168

WOOD DECK

Platform Size"	Deck Height"	Handle Height"	Wt. lbs.	Standard Corner	Diamond Tilt
24 x 48	11	40	110	MB130	MB133
30 x 48	11	40	130	MB138	MB141
30 x 60	11	40	140	MB142	MB145
36 x 72	11	40	175	MB155	MB157
48 x 96	11	40	240	MB166	MB169



- Steel deck made of a heavy-duty all-welded 11-gauge steel with reinforced channel formed deck
- Wood deck features a sturdy 2" x 2" angle iron frame with quality hardwood decking
- Removable 1-1/4" chrome handle can be placed at either end
- Two rigid and two swivel bolted-on casters

HEAVY-DUTY PLATFORM TRUCKS

PLATFORM TRUCKS - 10" FULL PNEUMATIC CASTERS

- Pneumatic casters offer excellent shock absorbing properties
- Rides smoothly over rough terrain and uneven surfaces
- Not recommend for floors with corrosive chemicals or sharp objects



1200 - LB. CAPACITY
Evenly Distributed

STEEL DECK

Platform Size"	Deck Height"	Handle Height"	Wt. lbs.	Standard Corner	Diamond Tilt
24 x 48	13	42	110	MB255	MB257
30 x 48	13	42	130	MB263	MB265
30 x 60	13	42	140	MB268	MB269
36 x 72	13	42	175	MB280	MB281
48 x 96	13	42	240	MB283	MB285

WOOD DECK

Platform Size"	Deck Height"	Handle Height"	Wt. lbs.	Standard Corner	Diamond Tilt
24 x 48	13	42	110	MB256	MB258
30 x 48	13	42	130	MB264	MB266
30 x 60	13	42	140	MB267	MB270
36 x 72	13	42	175	MB279	MB282
48 x 96	13	42	240	MB284	MB286



MB263



MB267

CASTER PLACEMENT



STANDARD

Standard corner pattern is two swivel wheels in the back and two rigid wheels in the front of the platform truck

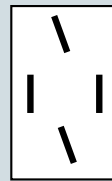

DIAMOND

Diamond tilt pattern allows the truck to tilt-balance slightly on the centre side wheels, allowing the truck to turn in its own length

REPLACEMENT CASTERS

Model No.	Description
ML853	8" Mold-on Rubber Rigid
ML852	8" Mold-on Rubber Swivel
ML865	8" Hi-Temp Nylon Rigid
ML864	8" Hi-Temp Nylon Swivel
MN223	10" Pneumatic Rigid
MN224	10" Pneumatic Swivel

ML853



ML852



ML865



ML864



MN223



MN224



REPLACEMENT HANDLES

Model No.	Description
MB218	24" Chrome Handle
MB221	30" Chrome Handle
MB224	36" Chrome Handle
MB226	48" Chrome Handle

PLATFORM TRUCKS

Customize KLETON
products to your specs!
See Inside Front Cover



ALL WOOD DECK PLATFORM TRUCKS

- Made of quality 7/8" hardwood with 5" x 1-5/8" hardwood sidewall
- Hardwood surface will not mar or scratch loads
- Removable 1-1/4" tubular chrome handle
- Mounted on two 12" wheels and two 6" swivel hi-temp nylon casters



MB122

**3000 - LB.
CAPACITY**

Evenly Distributed

Model No.	Platform Size			Deck Height"	Handle Height"	Wt. lbs.
	W"	x	L"			
MB122	24	x	48	15	44	150
MB123	30	x	48	15	44	170
MB124	30	x	60	15	44	195
MB125	36	x	60	15	44	210
MB126	36	x	72	15	44	230

REPLACEMENT PARTS

- Model No. **MC340**, 12" Phenolic Wheel
 Model No. **ML861**, 6" Swivel Hi-Temp Nylon Caster
 Model No. **MB218**, 24" Chrome Handle
 Model No. **MB221**, 30" Chrome Handle
 Model No. **MB224**, 36" Chrome Handle

PLATFORM WAGON TRUCKS

- Flush deck allows for easy loading/unloading of cargo
- Steel deck made of an all-welded 11-gauge steel
- Wood deck features a 2" x 2" angle iron frame with quality hardwood decking
- Ergonomic handle can be raised up to 45"
- Fifth wheel design allows for easier maneuvering
- T-handle with vinyl handgrips
- Rolls on four 10" pneumatic wheels
- Durable Kleton blue enamel finish



MD189

**1000 - LB.
CAPACITY**

Evenly Distributed

STEEL DECK		WOOD DECK		Platform Size		Deck Height"
Model No.	Wt. lbs.	Model No.	Wt. lbs.	W"	x L"	
MD187	130	MD186	120	24	x 48	14-1/4
MD189	170	MD188	150	30	x 60	14-1/4
MD193	210	MD192	190	36	x 72	14-1/4

REPLACEMENT PARTS

- Model No. **MA382**, Hand Grip
 Model No. **ML069**, 10" Pneumatic Wheel



MN413

ELEVATED PLATFORM TRUCKS

- All-welded steel construction, ready-to-use
- 11-gauge steel deck with 2" square tube frames
- 1-1/4" round tube handle extends 14" above deck
- Removable handle
- Durable Kleton blue enamel finish

Model No.	Platform Size			Deck Height"	Wheel Type	Capacity lbs.
	W"	x	L"			
MN413	24	x	48	28	8" Hi-Temp Nylon	2000
MN414	30	x	60	28	8" Hi-Temp Nylon	2000
MN415	24	x	48	28	8" Mold-On Rubber	1800
MN416	30	x	60	28	8" Mold-On Rubber	1800
MN417	24	x	48	31	10" Pneumatic	1000
MN418	30	x	60	31	10" Pneumatic	1000



Customize KLETON
products to your specs!
See Inside Front Cover

SPECIALIZED PLATFORM TRUCKS

SEMI LIVE SKIDS

- Ideal solution for removable temporary storage
- Heavy 11-gauge steel deck with reinforced channels
- 3/16" x 2" x 2" angle frame with hardwood deck
- 52" jack handle (sold separately) engages skids and converts them to portable truck
- Skids and handle roll on 8" Mold-on rubber wheels
- Can be stacked away when not in use
- Durable Kleton blue enamel finish

**2000 - LB.
CAPACITY**
Evenly Distributed

Model No.	Deck Size W" x L"	Deck Type	Deck Height"	Wt. lbs.
MB327	24 x 48	Steel	12	110
MB328	24 x 48	Wood	12	115
MB329	30 x 48	Steel	12	130
MB330	30 x 48	Wood	12	135
MB331	30 x 60	Steel	12	140
MB332	30 x 60	Wood	12	145
MB337	36 x 72	Steel	12	175
MB338	36 x 72	Wood	12	180
MB348	51" Jack Handle			30

REPLACEMENT PARTS

Model No. **ML853**, 8" Rigid Mold-On Rubber Wheel

Model No. **ML069**, 10" Pneumatic Wheel



DEAD SKIDS

- Tough and durable platforms for temporary storage and handling of material
- Heavy 11-gauge steel deck with reinforced channels
- 3/16" x 2" x 2" angle frame with hardwood deck
- Available with steel or hardwood decks
- Four sturdy steel legs keep loads off the floor
- Can be stacked when not in use
- Durable Kleton blue enamel finish

**2500 - LB.
CAPACITY**
Evenly Distributed

Model No.	Deck Size W" x L"	Platform Type	Deck Height"	Wt. lbs.
ML071	24 x 48	Steel	6	110
ML072	24 x 48	Wood	6	115
ML073	30 x 48	Steel	6	130
ML074	30 x 48	Wood	6	135
ML075	30 x 60	Steel	6	140
ML076	30 x 60	Wood	6	145
ML077	36 x 72	Steel	6	175
ML078	36 x 72	Wood	6	180



INSTITUTIONAL & FOLDABLE PLATFORM TRUCKS

INSTITUTIONAL PLATFORM TRUCKS

- All-welded 14-gauge steel platform
- Ideal for hospitals, restaurants, offices and any application where a professional appearance is required
- Double-welded sockets
- 2" turned down lip and reinforced channels underneath
- 1-1/4" tubular chrome handle with end panel
- Non-skid rubber mat surface prevents items from shifting and protects against scratches
- Rubber corner bumpers protect furniture and walls
- Two rigid and two swivel 5" bolted-on non-marking rubber casters
- Kleton blue powder coat finish
- Shipped knocked down



MB190



1200 - LB. CAPACITY

Evenly Distributed



Model No.	Platform Size W" x L" x H"	Handle Height"	Overall Dimensions W" x L" x H"	Wt. lbs.
MB190	24 x 36 x 8	36	26 x 38 x 36	64
MB208	24 x 48 x 8	36	26 x 50 x 36	70
MB207	30 x 48 x 8	36	32 x 50 x 36	88
MB209	30 x 60 x 8	36	32 x 62 x 36	100

REPLACEMENT PARTS

Model No. **MB220**, 24" Chrome Handle with Plate

Model No. **MB223**, 30" Chrome Handle with Plate

Model No. **MC043**, Corner Bumper

Model No. **ML338**, 5" Rigid Non-Marking Rubber Caster

Model No. **ML337**, 5" Swivel Non-Marking Rubber Caster

FOLDING HANDLE PLATFORM TRUCKS

- Ideal for moving supplies, forms and light equipment
- Heavy 16-gauge steel construction with non skid vinyl coated deck
- Entire platform is wrapped with a vinyl bumper to protect walls and furniture
- Quick-release handle folds flat for easy storage
- Two swivel and two rigid bolted-on rubber casters

440 - 660 - LB. CAPACITY

Evenly Distributed

MK989



Model No.	Platform Size W" x L"	Handle Height"	Caster Size	Folded Height"	Wt. lbs.
MK988	19 x 29	33	4"	8	28
MK989	23 x 35	33	5"	9	45

REPLACEMENT PARTS

Model No. **M0826**, 4" Rigid Rubber Caster

Model No. **M0827**, 4" Swivel Rubber Caster

Model No. **M0828**, 5" Rigid Rubber Caster

Model No. **M0829**, 5" Swivel Rubber Caster

FOLDABLE ALUMINUM PLATFORM TRUCKS

- Designed for situations that call for a solid, yet portable platform truck
- Interlocking aluminum frame has dual length platform: 20" L x 16" W or 28" L x 16" W
- Rubber corner bumpers to protect walls and furniture
- Folds down to a compact 20" L x 16" W x 9 1/2" H
- Comfortable 32" handle height
- Two swivel and two rigid bolted-on 4" rubber casters
- Weight: 19 lbs.

Model No. **MK990**

REPLACEMENT PARTS

Model No. **M0830**, 4" Rigid Rubber Caster

Model No. **M0831**, 4" Swivel Rubber Caster



300 - LB. CAPACITY

Evenly Distributed

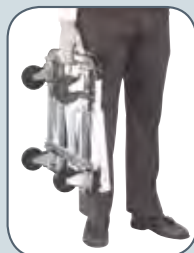

ALUMINUM PLATFORM TRUCKS

- Box frame made of high strength all-welded aluminum channel
- Corner sockets at both ends allow handles to be used on either end of the truck
- Rubber corner bumpers prevent damage to walls and furniture
- Wide variety of casters to suit any application

ALUMINUM PLATFORM TRUCKS



ML901

		SMOOTH DECK		TREAD PLATE DECK	
Platform Size"	Capacity lbs.	Model No.	Wt. lbs.	Model No.	Wt. lbs.
8" PNEUMATIC CASTERS					
24 x 36	1400	ML901	51	ML904	52
24 x 48	1400	ML902	55	ML905	57
30 x 60	1400	ML903	66	ML906	68



ML910

		SMOOTH DECK		TREAD PLATE DECK	
Platform Size"	Capacity lbs.	Model No.	Wt. lbs.	Model No.	Wt. lbs.
10" PNEUMATIC CASTERS					
24 x 36	1850	ML907	56	ML910	57
24 x 48	1850	ML908	60	ML911	62
30 x 60	1850	ML909	71	ML912	73



ML916

		SMOOTH DECK		TREAD PLATE DECK	
Platform Size"	Capacity lbs.	Model No.	Wt. lbs.	Model No.	Wt. lbs.
8" FLAT-FREE CASTERS					
24 x 36	1100	ML913	54	ML916	55
24 x 48	1100	ML914	58	ML917	60
30 x 60	1100	ML915	69	ML918	71



ML922

		SMOOTH DECK		TREAD PLATE DECK	
Platform Size"	Capacity lbs.	Model No.	Wt. lbs.	Model No.	Wt. lbs.
10" FLAT-FREE CASTERS					
24 x 36	1200	ML919	58	ML922	59
24 x 48	1200	ML920	62	ML923	64
30 x 60	1200	ML921	73	ML924	75

ALUMINUM PLATFORM TRUCKS

ALUMINUM PLATFORM TRUCKS

- Box frame made of high strength all-welded aluminum channel
- Corner sockets at both ends allow handles to be used on either end of the truck
- Rubber corner bumpers prevent damage to walls and furniture
- Wide variety of casters to suit any application



		SMOOTH DECK		TREAD PLATE DECK	
8" MOLD-ON RUBBER CASTERS					
Platform Size"	Capacity lbs.	Model No.	Wt. lbs.	Model No.	Wt. lbs.
24 x 36	2000	ML925	64	ML928	65
24 x 48	2000	ML926	68	ML929	70
30 x 60	2000	ML927	79	ML930	71



		SMOOTH DECK		TREAD PLATE DECK	
6" POLYURETHANE CASTERS					
Platform Size"	Capacity lbs.	Model No.	Wt. lbs.	Model No.	Wt. lbs.
24 x 36	3400	ML931	48	ML934	49
24 x 48	3400	ML932	52	ML935	54
30 x 60	3400	ML933	63	ML936	65



		SMOOTH DECK		TREAD PLATE DECK	
8" POLYURETHANE CASTERS					
Platform Size"	Capacity lbs.	Model No.	Wt. lbs.	Model No.	Wt. lbs.
24 x 36	4000	ML937	53	ML940	54
24 x 48	4000	ML938	57	ML941	59
30 x 60	4000	ML939	68	ML942	70

HARDWOOD DOLLIES

CHOOSE FROM 3 CASTER TYPES



POLYOLEFIN



BLUE ELASTIC RUBBER



POLYURETHANE



HARDWOOD DOLLIES

- Kiln dried
- Countersunk bolts prevent scratches
- Wood thickness: 7/8"
- Rounded edges and handles facilitate storage and mobility
- Shipped knocked down



MN204



MN217



MN200



* Dolly not included

Model No.	Size W" x D"	Caster Type	Caster Size"	Capacity lbs.*
ALL-WOOD				
MN189	18 x 24	Polyolefin	3	900
MN195	18 x 24	Polyurethane	3	900
MN201	18 x 24	Polyolefin	4	1000
MN207	18 x 24	Polyurethane	4	1600
MN213	18 x 24	Blue Elastic	4	1400
MN192	18 x 30	Polyolefin	3	900
MN198	18 x 30	Polyurethane	3	900
MN204	18 x 30	Polyolefin	4	1000
MN210	18 x 30	Polyurethane	4	1600
MN216	18 x 30	Blue Elastic	4	1400

CARPETED ENDS

MN190	18 x 24	Polyolefin	3	900
MN196	18 x 24	Polyurethane	3	900
MN202	18 x 24	Polyolefin	4	1000
MN208	18 x 24	Polyurethane	4	1600
MN214	18 x 24	Blue Elastic	4	1400
MN193	18 x 30	Polyolefin	3	900
MN199	18 x 30	Polyurethane	3	900
MN205	18 x 30	Polyolefin	4	1000
MN211	18 x 30	Polyurethane	4	1600
MN217	18 x 30	Blue Elastic	4	1400

RUBBER ENDS

MN191	18 x 24	Polyolefin	3	900
MN197	18 x 24	Polyurethane	3	900
MN203	18 x 24	Polyolefin	4	1000
MN209	18 x 24	Polyurethane	4	1600
MN215	18 x 24	Blue Elastic	4	1400
MN194	18 x 30	Polyolefin	3	900
MN200	18 x 30	Polyurethane	3	900
MN206	18 x 30	Polyolefin	4	1000
MN212	18 x 30	Polyurethane	4	1600
MN218	18 x 30	Blue Elastic	4	1400

*Evenly distributed

REPLACEMENT CASTERS

Model No. **ML391**, 3" Swivel Polyolefin

Model No. **ML393**, 4" Swivel Polyolefin

Model No. **ML044**, 3" Swivel Polyurethane

Model No. **ML045**, 4" Swivel Polyurethane

Model No. **ML333**, 4" Swivel Blue Elastic Rubber

WOOD DOLLY RACKS

- Converts a basic wood dolly into a multi-purpose panel caddy
- All-welded 1" tube design for durability
- Tubular steel rack is padded to prevent scratching or marring
- Durable Kleton blue enamel finish

Model No.	For Use with Wood Dollies	Overall Dimensions W" x D" x H"	Between Rail Clearance"	Wt. lbs.
MD549	24" D	18 x 24 x 43	16	12
MD550	30" D	18 x 30 x 43	16	15

SPECIALIZED DOLLIES

Customize KLETON products to your specs!
See Inside Front Cover



STEEL DECK DOLLIES

- Rugged dolly ideal for moving heavy loads
- 14-gauge steel construction
- Four bolted-on 4" swivel non-marking rubber casters
- Durable Kleton blue enamel finish

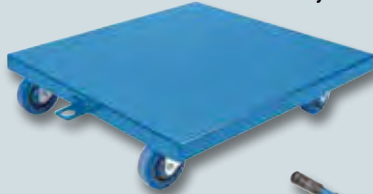

Optional T-handle facilitates movement with heavy loads

1200 - LB. CAPACITY

Evenly Distributed

Model No.	Overall Dimensions W" x L" x H"	Wt. lbs.
MA242	18 x 18 x 7	23
MA243	18 x 24 x 7	25
MA244	24 x 24 x 7	27
MA199	37" Length T-handle	5

REPLACEMENT PARTS

Model No. **ML333**, 4" Swivel Non-Marking Rubber Caster
Model No. **MA382**, Replacement Handgrip for T-Handle

ANGLE FRAME DOLLIES

- Heavy-duty all-welded 1/2" x 1/2" x 1/8" angle frame construction
- Built to withstand tough factory and warehouse environments
- Four bolted-on 4" swivel non-marking rubber casters
- Durable KLETON blue enamel finish

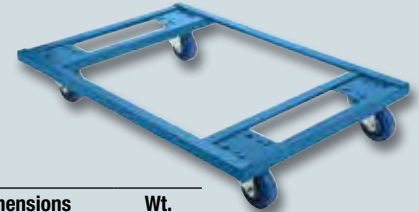

1200 - LB. CAPACITY

Evenly Distributed

Model No.	Overall Dimensions W" x L" x H"	Wt. lbs.
MA190	18 x 18 x 7	23
MA191	18 x 24 x 7	25
MA192	24 x 24 x 7	27
MA193	24 x 36 x 7	30

REPLACEMENT PARTS

Model No. **ML333**, 4" Swivel Non-Marking Rubber Caster

ALUMINUM DECK DOLLIES

- Ideal for a variety of transport applications
- 3/8" corrosion-resistant aluminum checker plate construction
- Four bolted-on 4" swivel non-marking rubber casters
- Natural aluminum finish

Model No.	Overall Dimensions W" x L" x H"	Wt. lbs.
MA196	18 x 18 x 6	25
MA197	18 x 24 x 6	27
MA198	24 x 24 x 6	30

REPLACEMENT PARTS

Model No. **ML333**, 4" Swivel Non-Marking Rubber Caster

Tread plate design for a non-slip load surface!



PREMIUM MEDIUM-DUTY 100% MAPLE WOOD DOLLIES

- 7/8" wood top; countersunk bolts
- Carpeted dolly will prevent marks and scratches on equipment being moved
- 3" polyolefin casters
- Shipped knocked down



900 - LB. CAPACITY

Evenly Distributed

Model No.	Dimensions W" x D"	Platform Type	Wt. lbs.
MA186	18 x 24	Standard	16
MA187	18 x 24	Carpeted	18
MD515	18 x 30	Standard	18
MD516	18 x 30	Carpeted	20

PREMIUM HEAVY-DUTY 100% MAPLE WOOD DOLLIES

- 1 3/4" wood top (2 x 7/8" pieces); countersunk bolts
- 4" resilient non-marking casters
- Shipped knocked down



1400 - LB. CAPACITY

Evenly Distributed

Model No.	Dimensions W" x D"	Platform Type	Wt. lbs.
MA188	18 x 24	Standard	20
MA189	18 x 24	Carpeted	22
MD517	18 x 30	Standard	22
MD518	18 x 30	Carpeted	24

Carpeted dolly will prevent marks and scratches on equipment

SPECIALIZED DOLLIES AND TRUCKS

MEDIUM-DUTY SOLID WOOD DOLLIES

- 7/8" wood top with countersunk bolts
- 3" polyolefin casters
- Shipped knocked down



Model No.	Overall Dimensions		Description	Wt. lbs.
	W" x L" x H"			
MP087	18 x 24 x 7		Wood-Top	32
MP088	18 x 24 x 7		Carpeted	34
MP089	18 x 32 x 7		Wood-Top	41
MP090	18 x 32 x 7		Carpeted	43

HEAVY-DUTY SOLID WOOD DOLLIES

- 1-3/4" wood top (2 x 7/8" pieces) with countersunk bolts
- 4" resilient non-marking casters
- Shipped knocked down



Model No.	Overall Dimensions		Description	Wt. lbs.
	W" x L" x H"			
MP091	18 x 24 x 7		Wood-Top	36
MP092	18 x 24 x 7		Carpeted	38
MP093	18 x 32 x 7		Wood-Top	49
MP094	18 x 32 x 7		Carpeted	51

PIPE & BAR CRADLE TRUCK

- All-welded steel construction, ready to use
- Raised ergonomic bed height of 20" is ideal for shop environment
- Cradle is 19-1/2" W x 14" H
- 6" heavy-duty swivel casters allow for greater maneuverability in tight spaces and can turn on their axes
- Single units are ideal for shorter loads and must be centered on the truck; multiple units can be combined for greater capacity and to support longer loads
- Recessed side decks allow for loading and unloading with a lift truck
- Durable Kleton blue enamel finish



2500 - LB. CAPACITY
Evenly Distributed

Model No.	Overall Dimensions		Wt. lbs.
	W" x L" x H"		
MP037	24 x 24 x 34		92
MP038	24 x 36 x 34		107
MP039	24 x 48 x 34		120

PALLET DOLLY

- Fits most standard pallets up to 42" x 48"
- Can be used with loaded or empty pallets
- (4) 6" swivel polyurethane casters, (2) with brakes
- Rugged, angle iron construction with load retention corner brackets
- 3000 lbs capacity
- Dimensions: 48-1/2" W x 43" D x 8" H

Model No. **MP044**



SPECIALIZED CARTS

Customize KLETON
products to your specs!
See Inside Front Cover



FRAME SHEET/PANEL CARTS

- Frame is constructed of all-welded 2" angle steel
- Ideal for handling long, flat, awkward loads
- Available with open or closed base
- Four bolted-on 5" non-marking rubber swivel casters
- Durable Kleton blue enamel finish

**1200 - LB.
CAPACITY**
Evenly Distributed



ML064



MD217

Model No.	Overall Dimensions W" x D" x H"	Base Type	Wt. lbs.
MD216	24 x 36 x 55	Open	50
ML063	24 x 36 x 55	Closed	60
MD217	30 x 42 x 55	Open	60
ML064	30 x 42 x 55	Closed	75
MD218	36 x 72 x 55	Open	85
ML065	36 x 72 x 55	Closed	110

REPLACEMENT PARTS

Model No. **ML337**, 5" Swivel Non-Marking Rubber

U-BOAT PLATFORM TRUCKS

- Tilt design allows truck to turn within its own radius
- 11-gauge steel deck is only 10" off the ground for easy loading
- Removable end racks constructed of 1-1/4" round steel tube
- Two 8" x 2" bolted-on rigid casters and four 5" swivel casters
- Durable Kleton blue enamel finish



MK970

**1500 - LB.
CAPACITY**
Evenly Distributed

Model No.	Overall Dimensions W" x D" x H"	Wt. lbs.
MK970	18 x 48 x 72	115
MK971	18 x 60 x 72	125

REPLACEMENT PARTS

Model No. **ML853**, 8" Rigid Mold-On Rubber

Model No. **ML846**, 5" Swivel Mold-On Rubber

BAR CRADLE CARTS

- Designed for efficient handling of long material
- Tilt design allows truck to turn within its own radius
- Cradle design facilitates loading and unloading
- Two 12" phenolic wheels and two 6" swivel hi-temp nylon casters
- Durable Kleton blue enamel finish

Model No.	Overall Dimensions W" x D" x H"	No. of cradles	Wt. lbs.
ML128	28 x 60 x 29	4	215
ML130	28 x 96 x 29	4	300
ML131	28 x 120 x 29	4	365

REPLACEMENT PARTS

Model No. **MC340**, 12" Phenolic Wheel

Model No. **ML861**, 6" Hi-Temp Nylon Swivel Caster



ML131

**5000-LB.
CAPACITY**



Customize KLETON products to your specs!
See Inside Front Cover

SPECIALIZED CARTS



ML139

DRYWALL CARTS

- All-welded multi-purpose cart is ideal for transporting drywall, wood or metal sheets
- 1-1/4" tubular rail handle and thick 11-gauge steel platform
- Two rigid and two swivel 8" bolted-on casters
- Kleton blue enamel finish

2000-3500 - LB. CAPACITY
Evenly Distributed

Model No.	Deck Dim. W" x L" x H"	Deck Angle°	Overall Dim. W" x L" x H"	Cap. lbs.	Caster Type	Wt. lbs.
ML139	15 x 44 x 14	80	24 x 44 x 44	2000	8" Mold-on Rubber	115
MD214	15 x 44 x 14	80	24 x 44 x 44	3500	8" Polyurethane	110

REPLACEMENT PARTS

- Model No. **ML402**, 8" Rigid Polyurethane
- Model No. **ML401**, 8" Swivel Polyurethane
- Model No. **ML853**, 8" Rigid Mold-On Rubber
- Model No. **ML852**, 8" Swivel Mold-On Rubber



MB729

LUMBER CARTS

- All-welded cart is ideal for transporting long and bulky items
- Welded 14-gauge 12" x 38" steel shelf
- Grey rubber bumpers protect walls and equipment
- Two rigid and two swivel bolted-on casters
- Kleton blue enamel finish

1200 - LB. CAPACITY
Evenly Distributed

Model No.	Deck Dim. W" x L" x H"	Shelf Height"	Overall Dim. W" x L" x H"	Caster Type	Wt. lbs
MB729	24 x 36 x 8	34	26 x 39 x 42	5" Rubber	80
ML140	24 x 36 x 10	36	26 x 39 x 45	6" Rubber	100

REPLACEMENT PARTS

- Model No. **ML338**, 5" Rigid Non-Marking Rubber Caster
- Model No. **ML337**, 5" Swivel Non-Marking Rubber Caster
- Model No. **ML850**, 6" Rigid Mold-On Rubber Caster
- Model No. **ML849**, 6" Swivel Mold-On Rubber Caster
- Model No. **MC043**, Grey Rubber Corner Bumper

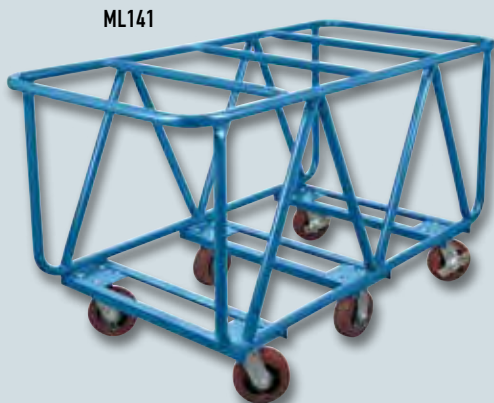

ML141

FLAT BED LUMBER CARTS

- All-welded cart is ideal for transporting large panel or sheets in a horizontal position
- Four 6" swivel and two 6" rigid bolted-on non-marking polyurethane casters
- Kleton blue enamel finish

2500 - LB. CAPACITY
Evenly Distributed

Model No.	Overall Dimensions W" x D" x H"	Wt. lbs
ML141	30 x 60 x 33	160

REPLACEMENT PARTS

- Model No. **ML400**, 6" Rigid Polyurethane
- Model No. **ML399**, 6" Swivel Polyurethane

SPECIALIZED CARTS

Customize KLETON
products to your specs!
See Inside Front Cover



HEAVY-DUTY PANEL AND LUMBER MOVER CARTS

- All-welded truck ideal for transporting large sheets and long parts
- Constructed from 1-1/4" round tubing and an 11-gauge deck
- Uprights extend 21" and 33" above deck
- Deck is 12" off the floor
- 8" clear space between tubes
- Two rigid and two swivel 8" casters
- Durable KLETON blue enamel finish

**2000-2500 - LB.
CAPACITY**
Evenly Distributed



SINGLE LEVEL RAILS HEAVY-DUTY PANEL MOVER CARTS

- All-welded truck ideal for transporting large sheets and long parts
- Constructed from 1-1/4" round tubing and an 11-gauge deck
- Uprights extend 33" above deck
- Deck is 12" off the floor
- Overall height is 45"
- 8" clear space between tubes
- Two rigid and two swivel 8" casters
- Durable KLETON blue enamel finish

**2000-2500 - LB.
CAPACITY**
Evenly Distributed



Model No.	Dimensions W" x L" x H"	Caster Type	Cap. lbs.	Wt. lbs.
ML360	30 x 48 x 45	Mold-on Rubber	2000	160
ML361	30 x 48 x 45	Polyurethane	2500	175
ML362	30 x 60 x 45	Mold-on Rubber	2000	160
ML363	30 x 60 x 45	Polyurethane	2500	175

Model No.	Dimensions W" x L" x H"	Caster Type	Cap. lbs.	Wt. lbs.
ML549	30 x 48 x 45	Mold-on Rubber	2000	139
ML550	30 x 48 x 45	Polyurethane	2500	139
ML551	30 x 60 x 45	Mold-on Rubber	2000	161
ML552	30 x 60 x 45	Polyurethane	2500	161

REPLACEMENT PARTS

- Model No. **ML401**, 8" Swivel Polyurethane
 Model No. **ML852**, 8" Swivel Mold-On Rubber
 Model No. **ML402**, 8" Rigid Polyurethane
 Model No. **ML853**, 8" Rigid Mold-On Rubber

REPLACEMENT PARTS

- Model No. **ML401**, 8" Swivel Polyurethane
 Model No. **ML852**, 8" Swivel Mold-On Rubber
 Model No. **ML402**, 8" Rigid Polyurethane
 Model No. **ML853**, 8" Rigid Mold-On Rubber

HEAVY-DUTY WORKHORSES

- Overbuilt to be the last sawhorse you'll ever need
- Powder coated finish safety yellow

Model No.	Height"	Width"	Depth"	Wt. lbs.
VC157	24	36	20	43
VC158	36	48	20	60

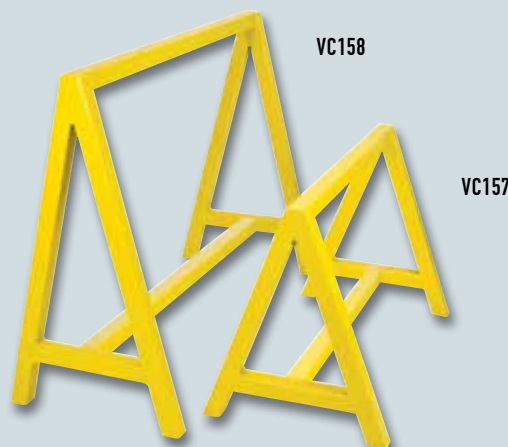

**2000 - LB.
CAPACITY**
Evenly Distributed



Customize KLETON
products to your specs!
See Inside Front Cover

SPECIALIZED TRUCKS & CARTS



M0522



M0523

KNOCKED-DOWN PANEL TRUCKS

- Move tables, drywall, plywood, artwork with ease
- Move light to heavy duty objects easily with (4) 5" non-marking blue elastic swivel casters
- Removable upright panel bars fit any size load
- Ships knocked-down for freight savings and damage avoidance
- Capacity is based on evenly distributed weight

Model No.	Deck Type	Overall Dimensions W" x L" x H"	Caster Size	Capacity lbs
M0522	Open-Deck	27 x 30 x 43	5" Rubber	80
M0523	Carpeted	27 x 30 x 43	5" Rubber	100



M0215

PORTABLE WIRE REEL CADDY

- Mobile storage for wire spools, reels, and cables
- Ideal for electricians, contractors and builders
- Ready to use, all-welded steel construction
- Rolls on 8" mold-on rubber wheels
- 4 clip-in-place rods for easy spool change
- Holds up to 8" diameter spools on top 3 rods
- Holds up to 12" diameter spools on lower rod
- Durable Kleton blue enamel finish
- Load capacity is based on evenly distributed weight
- Capacity: 400 lbs.
- Cart Material: Steel
- Overall Width: 24-1/2"
- Overall Height: 49"
- Overall Depth: 23"
- Weight: 52 lbs.

Model No. **M0215**



Features convenient
4" wide tool tray included



MOBILE WIRE SPOOL CART

- 6 removable spool rods (3 per side)
- Two 18" wide louvered panels on each end
- 5" non-marking blue rubber casters; 2 swivel with brake and 2 rigid
- Extended push handle on the end with the swivel casters
- Durable Kleton blue enamel finish
- Capacity: 1200 lbs.
- Cart Material: Steel
- Overall Width: 21"
- Overall Height: 48"
- Overall Depth: 38"
- Construction: All-Welded
- Rod Quantity: 6

Model No. **MP086**

CASTERS

BLUE ELASTIC RUBBER CASTERS

- High load capacity, rolls easily and quietly on all floors
- Non-marking, excellent floor protection
- Zinc chrome plated finish provides corrosion resistance
- Elastic rubber tread rejects floor debris
- Sealed double ball raceway
- Thread guards
- Ball bearing
- Total locking brake locks the wheel and keeps the swivel from turning

Model No.	Wheel Dia."	Style	Cap. lbs.	Tread Width"	Overall Height"
MO511*	3	Swivel	285	1-3/8	4-1/4
MO512*	3	Rigid	285	1-3/8	4-1/4
MO513*	3	Total locking brake	285	1-3/8	4-1/4
ML333	4	Swivel	350	1-3/8	5
ML334	4	Rigid	350	1-3/8	5
ML342	4	Total locking brake	350	1-3/8	5
ML337	5	Swivel	400	1-3/8	6
ML338	5	Rigid	400	1-3/8	6
ML345	5	Total locking brake	400	1-3/8	6

*Roller Bearing

RIGID

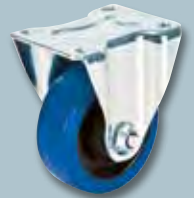

SWIVEL



TOTAL LOCKING BRAKE



PLATE SIZE:
3-3/8" x 4"

BOLT HOLE CENTRES:
2-3/8" x 3-1/8"

BOLT HOLE SIZE:
5/16"

POLYURETHANE CASTERS

- Smooth rolling, low noise operation
- Non-marking, cut & tear resistant
- Die cast aluminum core with brown polyurethane tread
- Resistant to most chemicals, moisture friendly
- Double ball raceway
- Annular ball bearing
- Total locking brake locks the wheel and keeps the swivel from turning
- Butterfly side brake locks the wheel preventing it from rolling

Model No.	Wheel Dia."	Style	Cap. lbs.	Tread Width"	Overall Height"
ML044	3	Swivel	230	1-1/4	4-1/4
ML043	3	Rigid	230	1-1/4	4-1/4
ML045	4	Swivel	440	1-1/2	5-5/8
ML046	4	Rigid	440	1-1/2	5-5/8
ML441	4HD	Swivel	550	1-5/8	5-5/8
ML442	4HD	Rigid	550	1-5/8	5-5/8
MN264	4HD	Total locking brake	550	1-5/8	5-5/8
ML397	5	Swivel	650	1-1/2	6-1/2
ML398	5	Rigid	650	1-1/2	6-1/2
MN265	5	Total locking brake	650	1-1/2	6-1/2
ML399	6	Swivel	850	1-1/2	7-1/2
ML400	6	Rigid	850	1-1/2	7-1/2
MN266	6	Total locking brake	850	1-1/2	7-1/2
MN449	6	Butterfly side brake	850	1-1/2	7-1/2
ML401	8	Swivel	1000	1-5/8	9-1/2
ML402	8	Rigid	1000	1-5/8	9-1/2
MN267	8	Total locking brake	1000	1-5/8	9-1/2
MN450	8	Butterfly side brake	1000	1-5/8	9-1/2

RIGID



SWIVEL



TOTAL LOCKING BRAKE



BUTTERFLY SIDE BRAKE



PLATE SIZE:

3 = 2-5/8" x 3-3/4"
4 = 3-1/8" x 4-1/8"
4 HD = 4" x 4-1/2"
5 = 4" x 4-1/2"
6 = 4" x 4-1/2"
8 = 4" x 4-1/2"

BOLT HOLE CENTRES:

3 = 1-3/4" x 2-3/4"
4 = 2-3/8" x 3-1/16"
4 HD = 3-1/4" x 2-3/4"
5 = 3-1/4" x 2-3/4"
6 = 3-1/4" x 2-3/4"
8 = 3-1/4" x 2-3/4"

BOLT HOLE SIZE:

3 = 5/16"
4 = 5/16"
4 HD = 3/8"
5 = 3/8"
6 = 3/8"
8 = 3/8"

CASTERS

POLYOLEFIN CASTERS

- Rolls easily on most floors
- Lightweight and economical
- Non-marking, easy to maintain, steam cleanable
- High impact strength
- Superior resistance to most oils, chemicals, grease and acids

Model No.	Wheel Dia."	Style	Cap. lbs.	Tread Width"	Overall Height"
ML391	3	Swivel	250	1-1/4	4-1/2
ML392	3	Rigid	250	1-1/4	4-1/2
ML393	4	Swivel	250	1-1/4	5-1/4
ML394	4	Rigid	250	1-1/4	5-1/4
ML395	5	Swivel	250	1-1/4	6-1/8
ML396	5	Rigid	250	1-1/4	6-1/8

PLATE SIZE: 2-5/8" x 3-3/4"

BOLT HOLE CENTRES: 1-3/4" x 2-7/8"

BOLT HOLE SIZE: 5/16"

RIGID



SWIVEL



HI-TEMP NYLON CASTERS

- Smooth rolling, non-marking
- Zinc chrome plated finish provides corrosion resistance
- Superior resistance to most oils, chemicals, and grease
- Double ball raceway
- Ball bearing
- Total locking brake locks the wheel and keeps the swivel from turning
- Butterfly side brake locks the wheel preventing it from rolling

Model No.	Wheel Dia."	Style	Cap. lbs.	Tread Width"	Overall Height"
ML861	6	Swivel	800	1-3/4	7-5/8
ML862	6	Rigid	800	1-3/4	7-5/8
ML863	6	Total locking brake	800	1-3/4	7-5/8
MN453	6	Butterfly side brake	800	1-3/4	7-5/8
ML864	8	Swivel	850	1-3/4	9-1/2
ML865	8	Rigid	850	1-3/4	9-1/2
ML866	8	Total locking brake	850	1-3/4	9-1/2
MN454	8	Butterfly side brake	850	1-3/4	9-1/2

PLATE SIZE:

4" x 4-1/2"

BOLT HOLE CENTERS:

3" x 3-1/3"

BOLT HOLE SIZE:

7/16"

RIGID



SWIVEL



TOTAL LOCKING
BRAKE



BUTTERFLY SIDE
BRAKE



CASTERS

MOLD-ON RUBBER CASTERS

- Molded rubber wheel permanently bonded to spoked cast iron core
- Iron centre gives it strength while the molded rubber offers smooth and quiet operation
- Protects loads and surfaces
- Won't damage warehouse or factory floors
- Bearing type: Roller
- Excellent for heavy loads and Industrial equipment

Model No.	Wheel Dia."	Style	Cap. lbs.	Tread Width"	Bearing Type
ML846	5	Swivel	400	2	Roller
ML847	5	Rigid	400	2	Roller
ML849	6	Swivel	500	2	Roller
ML850	6	Rigid	500	2	Roller
ML851	6	Total locking brake	500	2	Roller
MN451	6	Butterfly side brake	500	2	Roller
ML852	8	Swivel	600	2	Roller
ML853	8	Rigid	600	2	Roller
ML854	8	Total locking brake	600	2	Roller
MN452	8	Butterfly side brake	600	2	Roller

PLATE SIZE: 4" x 4-1/2"

BOLT HOLE CENTERS: 2-7/8" x 3-1/3"

BOLT HOLE SIZE: 7/16"

RIGID



SWIVEL



TOTAL LOCKING BRAKE



BUTTERFLY SIDE BRAKE



PNEUMATIC CASTERS

- Four ply pneumatic casters offer smooth and quiet rolling over the roughest surfaces and outdoor terrain
- Shock absorbing properties give the greatest possible protection to both the load and floor
- The "Air cushion" feature will transport the most fragile material and instruments without damage
- Not recommended for floors with metal shavings or corrosive chemicals

Model No.	Wheel Dia."	Style	Cap. lbs.	Tread Width"	Overall Height"
MN222	8	Swivel	350	2	10
MN221	8	Rigid	350	2	10
MN224	10	Swivel	400	3	12
MN223	10	Rigid	400	3	12

Note: For optimum use pneumatic wheels must be properly inflated

REPLACEMENT PARTS

Model No. **MN372**, Inner tube for **MN221** & **MN222**

Model No. **MN373**, Inner tube for **MN223** & **MN224**

PLATE SIZE: 4" x 4-1/2"

BOLT HOLE CENTERS: 2-3/4" x 3-3/8"

BOLT HOLE SIZE: 13/32"

RIGID



SWIVEL



CASTERS

NYLON SANDWICH CASTERS

- Non-marking white nylon elastic rubber cushion ring layer reduces noise and vibration
- Ideal for use on concrete, brick, carpet and steel
- Chrome zinc-finish for corrosion resistance
- Double raceway
- Ball bearing
- Total locking brake locks the wheel and keeps the swivel from turning

Model No.	Wheel Dia."	Style	Cap. lbs.	Tread Width"	Overall Height"
MN441	4	Swivel	440	1-3/8	5-1/8
MN442	4	Rigid	440	1-3/8	5-1/8
MN443	4	Total locking brake	440	1-3/8	5-1/8
MN444	5	Swivel	440	1-3/8	6-1/8
MN445	5	Rigid	440	1-3/8	6-1/8
MN446	5	Total locking brake	440	1-3/8	6-1/8

PLATE SIZE: 3 1/3" x 4 1/8"

BOLT HOLE CENTRES: 3 1/8" x 2 1/3"

BOLT HOLE SIZE: 5/16"

RIGID



SWIVEL



TOTAL LOCKING BRAKE



FLAT-FREE CASTERS

- Solid polyurethane wheel never runs flat
- Ideal for use on concrete, brick, carpet, steel, tile, asphalt, wood and linoleum
- Same bounce feel and weight of a pneumatic caster
- Smooth and quiet rolling over rough terrain and surfaces
- Less costly than traditional foam-filled tires
- Ball bearing

Model No.	Wheel Dia."	Style	Cap. lbs.	Tread Width"	Overall Height"
MN226	8	Swivel	275	2	10
MN225	8	Rigid	275	2	10
MN228	10	Swivel	300	3	12
MN227	10	Rigid	300	3	12

PLATE SIZE: 4" x 4-1/2"

BOLT HOLE CENTERS: 2-3/4" x 3-3/8"

BOLT HOLE SIZE: 13/32"

RIGID



SWIVEL



SEMI-PNEUMATIC WHEEL

- Soft rubber tread with steel hub and ball bearings for quiet movement
- Excellent for dollies, floor protection, quiet operation, light duty stock trucks
- Wheel Diameter: 10"
- Capacity: 200 lbs.
- Bore Size: 3-3/4"
- Tread Width: 2-1/2"
- Temperature: -20°F to 130°F
- Durometer: 85 - 90 A scale
- Hub Type: Offset

Model No. **MO888**



VEHICLE SERVICE EQUIPMENT

PREVENT ACCIDENTS! Chocks are designed to provide maximum gripping power on almost any surface, wet or dry. They are resistant to sun, moisture, salt, oil and meet OSHA requirements.

DOUBLE SIDED RUBBER CHOCKS

- Fabricated of a tough rubber compound, reinforced for maximum wearability and strength

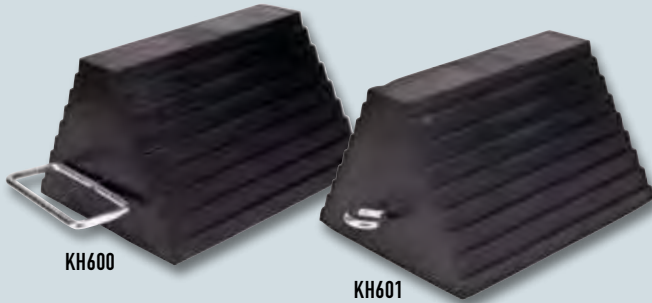

Model No.	Type	Approx. Size W" x L" x H"	Wt. lbs.
KH600	Handle	8 x 9 x 6	10
KH601	Eye Bolt	8 x 9 x 6	10

URETHANE WHEEL CHOCK

- Safety orange colour for greater visibility
- Molded-in hole through width of chock for attaching security chain (chain sold separately)
- Overall size: 8" W x 11" L x 8" H
- Weight: 4 lbs.

Model No. **KH897**



LAMINATED RUBBER CHOCK

- Designed to fit curvature of tire for a strong grip
- Extra heavy-duty laminated rubber and steel construction for use with heavy utility trucks and equipment
- Load capacity: Up to 40 000 lbs.



Model No.	Construction	Approx. Size W" x L" x H"	Wt. lbs.
KH603	Laminated	8 x 8 x 8	14

INDUSTRIAL DUTY RUBBER WHEEL CHOCK

- Highly resistant to abrasion, impacts, corrosion, sun, salt, ozone and oil
- Steel ring on back
- 6-1/2" W x 9-1/2" L x 7-1/2" H
- Weight: 12.5 lbs.

Model No. **KH032**

KH032



HEAVY-DUTY RUBBER WHEEL CHOCK

- Highly resistant to abrasion, impacts, corrosion, sun, salt, ozone and oil
- Handle on back for easy placement
- 8-5/8" W x 10-5/8" D x 7" H
- Weight: 22 lbs
- 40" max tire diameter

Model No. **KI252**

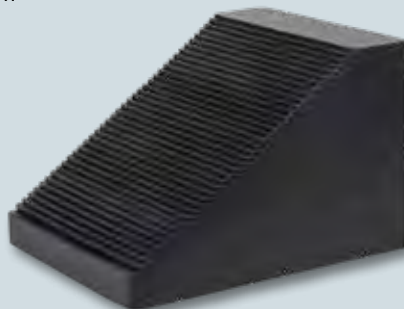

STANDARD DUTY RUBBER WHEEL CHOCK

- Constructed of reinforced rubber
- Resists tearing, abrasions, impacts, corrosion, sun, salt and oil
- Back handle
- 7-1/8" W x 9-7/8" L x 7-1/2" H
- Weight: 9.5 lbs.

Model No. **KH893**

KH893

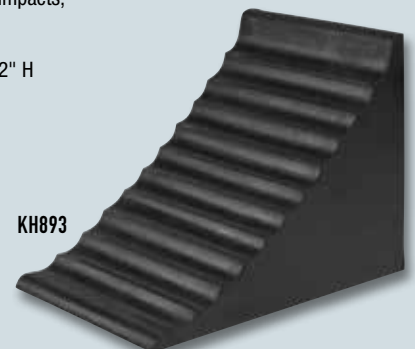

PREVENT ACCIDENTS! Chocks are designed to provide maximum gripping power on almost any surface, wet or dry. They are resistant to sun, moisture, salt, oil and meet OSHA requirements.

VEHICLE SERVICE EQUIPMENT

ICE CHOCK

- Formed steel
- "Tooth" like bottom assures reliable grip
- Lightweight and dependable
- Maximum holding power for snow and ice
- Overall dimensions: 10-1/2" L x 8" W x 9-1/4" H
- Powder-coated safety yellow finish for high visibility
- Weight: 9 lbs.

Model No. **KH964**

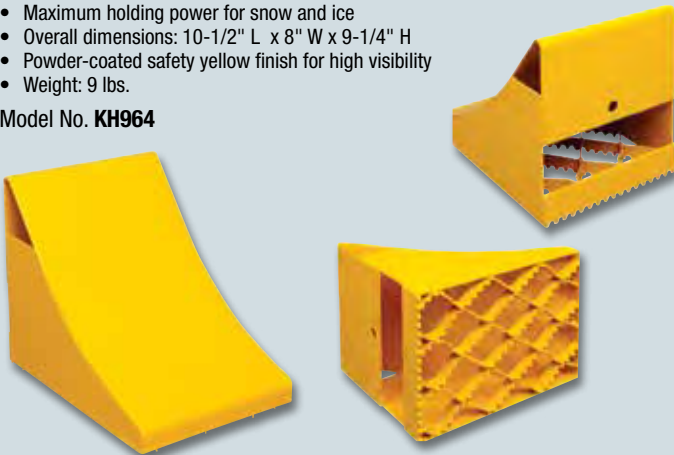

WHEEL CHOCK WALL BRACKET

- Sturdy yellow metal construction
- Fits most sizes of wheel chocks (e.g. **KH032, KH603**)
- Prevents loss of chock

Model No. **KH963**



MOLDED DOCK BUMPERS

- Protects building and dock areas
- Shockproof, tear and freeze resistant

KH005

KH009



TRAILER STABILIZING JACK

- Keeps tractorless trailers leveled while being loaded or unloaded
- Prevents accidents if wheel support collapses
- Stabilizes vehicle against load shifts
- Lowered height: 39-1/2"
- Raised height: 51"
- Removeable 37-1/2" positioning and ratcheting handle
- 8" dia support pad
- 8" wheels
- 100 000 lbs. supporting capacity each and 40 000 lbs. lifting capacity each
- 1 year warranty
- Recommended use in pairs

Model No. **KH777**



Model No.	Type	Face size W" x H"	Overall Projection"	Wt. lbs.
KH005	Rectangular	13 x 10	4	16
KH009	Rectangular	18 x 10	4	32

CORNER BUMPER

- Protects a wide variety of mobile equipment and the surrounding environment from bumps and scrapes
- Non-marking rubber construction
- Comes equipped with a steel insert and 4 self tapping screws allowing bumper to be mounted on any flat surface
- Thickness: 7/8"
- Dimensions: 4" L x 4" W x 1" H

Model No. **MC043**





SHOP & INDUSTRIAL FURNITURE

Workbenches	66 - 80	Heavy-Duty Workbenches	83
Workbench Leg & Pedestals	75	Folding Tables	84
Workbench Tops	76	Folding Chairs	85
Workbench Components	77	Folding Benches	85
Modu-Bench Workbenches	78 - 79	Cork Boards	86
Mobile Workbenches	80 - 81	White Boards	86 - 87
Mobile Cabinet Benches	80 - 81	Step Stools	86
Mobile Tool Box Benches	81	Shop Desks	88
Cabinet Workbenches	82	Locker Room Benches	88

GET THE PERFECT WORKBENCH FOR YOUR NEEDS

Check out these options, and then select from one of our pre-designed models on pages 65-74.

6

Top Styles

- Steel - Wood Filled Top
- Laminated Wood
- Shop Top
- Plastic Laminate
- Laminated Wood Top
1-1/4" or 1-3/4"
- Rounded Laminate Top
1-1/4" or 1-3/4"

See Page 76 for details

2

Leg Types

- Industrial Duty
1000 lb. capacity
- Heavy Duty
2500 lb. capacity

See Page 77 for details



8

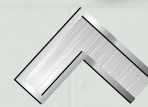

Pedestal Styles

- Full Door
- Two-Door
- Two-Drawer, 1 Door
- Two-Drawer
- Three-Drawer
- Four-Drawer
- Four-Drawer, One door
- Six-Drawer

See Page 75 for details

WORKBENCHES



INDUSTRIAL DUTY - 1000 LBS. CAPACITY, ADJUSTABLE LEGS

TOPS	24" x 60"	30" x 60"	30" x 72"	36" x 60"	36" x 72"
	STEEL - WOOD FILL TOP				
	FN049	FN050	FN051	FN052	FN053
	LAMINATED WOOD TOP - 1 3/4"				
	FN054	FN055	FN056	FN057	FN058
	SHOP TOP				
	FN059	FN060	FN061	FN062	FN063
	PLASTIC LAMINATE TOP				
	FN064	FN065	FN066	FN067	FN068
	LAMINATED WOOD TOP - 1 1/4"				
	FN269	FN270	FN271	FN272	FN273

HEAVY DUTY - 2500 LBS. CAPACITY

TOPS	24" x 60"	30" x 60"	30" x 72"	36" x 60"	36" x 72"
	STEEL - WOOD FILL TOP				
	FF667	FF669	FF670	FF671	FF672
	LAMINATED WOOD TOP - 1 3/4"				
	FF653	FF655	FF656	FF657	FF658
	SHOP TOP				
	FH878	FF676	FF677	FH877	FF679
	PLASTIC LAMINATE TOP				
	FH880	FF662	FF663	FH879	FF665
	LAMINATED WOOD TOP - 1 1/4" - 1500 LBS CAPACITY				
	FM948	FM949	FM950	FM951	FM952

INDUSTRIAL DUTY - 1000 LBS. CAPACITY, ADJUSTABLE LEGS

TOPS	24" x 60"	30" x 60"	30" x 72"	36" x 60"	36" x 72"
	STEEL - WOOD FILL TOP				
	FN089	FN090	FN091	FN092	FN093
	LAMINATED WOOD TOP - 1 3/4"				
	FN094	FN095	FN096	FN097	FN098
	SHOP TOP				
	FN099	FN100	FN101	FN102	FN103
	PLASTIC LAMINATE TOP				
	FN104	FN105	FN106	FN107	FN108
	LAMINATED WOOD TOP - 1 1/4"				
	FN279	FN280	FN281	FN282	FN283





HEAVY DUTY - 2500 LBS. CAPACITY

TOPS	24" x 60"	30" x 60"	30" x 72"	36" x 60"	36" x 72"
	STEEL - WOOD FILL TOP				
	FG289	FG290	FG291	FG292	FG293
	LAMINATED WOOD TOP - 1 3/4"				
	FG281	FG282	FG283	FG284	FG285
	SHOP TOP				
	FG286	FG294	FG295	FH885	FG296
	PLASTIC LAMINATE TOP				
	FH886	FG286	FG287	FH887	FG288
	LAMINATED WOOD TOP - 1 1/4" - 1500 LBS CAPACITY				
	FM958	FM959	FM960	FM961	FM962







WORKBENCHES

INDUSTRIAL DUTY - 1000 LBS. CAPACITY, ADJUSTABLE LEGS





TOPS	24" x 60"	30" x 60"	30" x 72"	36" x 60"	36" x 72"
	STEEL - WOOD FILL TOP				
	FN069	FN070	FN071	FN072	FN073
	LAMINATED WOOD TOP - 1 3/4"				
	FN074	FN075	FN076	FN077	FN078
	SHOP TOP				
	FN079	FN080	FN081	FN082	FN083
	PLASTIC LAMINATE TOP				
	FN084	FN085	FN086	FN087	FN088
	LAMINATED WOOD TOP - 1 1/4"				
	FN274	FN275	FN276	FN277	FN278

HEAVY DUTY - 2500 LBS. CAPACITY





TOPS	24" x 60"	30" x 60"	30" x 72"	36" x 60"	36" x 72"
	STEEL - WOOD FILL TOP				
	FF700	FF702	FF703	FF706	FF707
	LAMINATED WOOD TOP - 1 3/4"				
	FF686	FF688	FF689	FF690	FF691
	SHOP TOP				
	FH882	FF712	FF713	FH881	FF715
	PLASTIC LAMINATE TOP				
	FH884	FF695	FF696	FH883	FF698
	LAMINATED WOOD TOP - 1 1/4" - 1500 LBS CAPACITY				
	FM953	FM954	FM955	FM956	FM957



INDUSTRIAL DUTY - 1000 LBS. CAPACITY, ADJUSTABLE LEGS

TOPS	24" x 60"	30" x 60"	30" x 72"	36" x 60"	36" x 72"
	STEEL - WOOD FILL TOP				
	FN109	FN110	FN111	FN112	FN113
	LAMINATED WOOD TOP - 1 3/4"				
	FN114	FN115	FN116	FN117	FN118
	SHOP TOP				
	FN119	FN120	FN121	FN122	FN123
	PLASTIC LAMINATE TOP				
	FN124	FN125	FN126	FN127	FN128
	LAMINATED WOOD TOP - 1 1/4"				
	FN284	FN285	FN286	FN287	FN288

HEAVY DUTY - 2500 LBS. CAPACITY

TOPS	24" x 60"	30" x 60"	30" x 72"	36" x 60"	36" x 72"
	STEEL - WOOD FILL TOP				
	FG104	FG106	FG107	FG108	FG109
	LAMINATED WOOD TOP - 1 3/4"				
	FG090	FG092	FG093	FG094	FG095
	SHOP TOP				
	FH890	FG113	FG114	FH889	FG116
	PLASTIC LAMINATE TOP				
	FH892	FG099	FG100	FH891	FG102
	LAMINATED WOOD TOP - 1 1/4" - 1500 LBS CAPACITY				
	FM963	FM964	FM965	FM966	FM967

WORKBENCHES

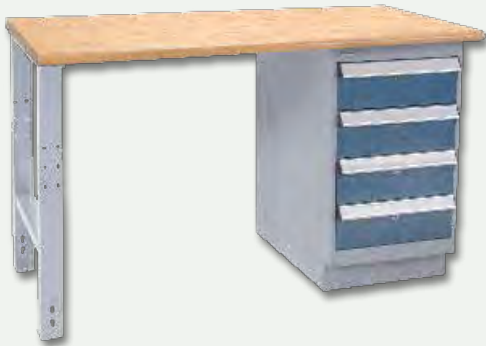

INDUSTRIAL DUTY - 1000 LBS. CAPACITY, ADJUSTABLE LEGS

TOPS	24" x 60"	30" x 60"	30" x 72"	36" x 60"	36" x 72"
	STEEL - WOOD FILL TOP				
	FN129	FN130	FN131	FN132	FN133
	LAMINATED WOOD TOP - 1 3/4"				
	FN134	FN135	FN136	FN137	FN138
	SHOP TOP				
	FN139	FN140	FN141	FN142	FN143
	PLASTIC LAMINATE TOP				
	FN144	FN145	FN146	FN147	FN148
	LAMINATED WOOD TOP - 1 1/4"				
	FN289	FN290	FN291	FN292	FN293

HEAVY DUTY - 2500 LBS. CAPACITY

TOPS	24" x 60"	30" x 60"	30" x 72"	36" x 60"	36" x 72"
	STEEL - WOOD FILL TOP				
	FG273	FG274	FG275	FG276	FG277
	LAMINATED WOOD TOP - 1 3/4"				
	FG265	FG266	FG267	FG268	FG269
	SHOP TOP				
	FH894	FG278	FG279	FH893	FG280
	PLASTIC LAMINATE TOP				
	FH896	FG270	FG271	FH895	FG272
	LAMINATED WOOD TOP - 1 1/4" - 1500 LBS CAPACITY				
	FM968	FM969	FM970	FM971	FM972

INDUSTRIAL DUTY - 1000 LBS. CAPACITY, ADJUSTABLE LEGS

TOPS	24" x 60"	30" x 60"	30" x 72"	36" x 60"	36" x 72"
	STEEL - WOOD FILL TOP				
	FN149	FN150	FN151	FN152	FN153
	LAMINATED WOOD TOP - 1 3/4"				
	FN154	FN155	FN156	FN157	FN158
	SHOP TOP				
	FN159	FN160	FN161	FN162	FN163
	PLASTIC LAMINATE TOP				
	FN164	FN165	FN166	FN167	FN168
	LAMINATED WOOD TOP - 1 1/4"				
	FN294	FN295	FN296	FN297	FN298





HEAVY DUTY - 2500 LBS. CAPACITY

TOPS	24" x 60"	30" x 60"	30" x 72"	36" x 60"	36" x 72"
	STEEL - WOOD FILL TOP				
	FG443	FG444	FG642	FG641	FG640
	LAMINATED WOOD TOP - 1 3/4"				
	FG639	FG638	FG637	FG636	FG635
	SHOP TOP				
	FH898	FG647	FG646	FH897	FG645
	PLASTIC LAMINATE TOP				
	FH900	FG650	FG649	FH899	FG648
	LAMINATED WOOD TOP - 1 1/4" - 1500 LBS CAPACITY				
	FM973	FM974	FM975	FM976	FM977







WORKBENCHES

INDUSTRIAL DUTY - 1000 LBS. CAPACITY, ADJUSTABLE LEGS



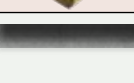

TOPS	24" x 60"	30" x 60"	30" x 72"	36" x 60"	36" x 72"
	STEEL - WOOD FILL TOP				
	FN173	FN172	FN171	FN170	FN169
	LAMINATED WOOD TOP - 1 3/4"				
	FN178	FN177	FN176	FN175	FN174
	SHOP TOP				
	FN183	FN182	FN181	FN180	FN179
	PLASTIC LAMINATE TOP				
	FN188	FN187	FN186	FN185	FN184
	LAMINATED WOOD TOP - 1 1/4"				
	FN333	FN332	FN331	FN330	FN329

HEAVY DUTY - 2500 LBS. CAPACITY





TOPS	24" x 60"	30" x 60"	30" x 72"	36" x 60"	36" x 72"
	STEEL - WOOD FILL TOP				
	FI556	FI555	FI554	FI553	FI552
	LAMINATED WOOD TOP - 1 3/4"				
	FI561	FI560	FI559	FI558	FI557
	SHOP TOP				
	FI566	FI565	FI564	FI563	FI562
	PLASTIC LAMINATE TOP				
	FI571	FI570	FI569	FI568	FI567
	LAMINATED WOOD TOP - 1 1/4" - 1500 LBS CAPACITY				
	FN013	FN012	FN011	FN010	FN009

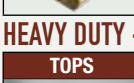

INDUSTRIAL DUTY - 1000 LBS. CAPACITY, ADJUSTABLE LEGS

TOPS	24" x 60"	30" x 60"	30" x 72"	36" x 60"	36" x 72"
	STEEL - WOOD FILL TOP				
	FN193	FN192	FN191	FN190	FN189
	LAMINATED WOOD TOP - 1 3/4"				
	FN198	FN197	FN196	FN195	FN194
	SHOP TOP				
	FN203	FN202	FN201	FN200	FN199
	PLASTIC LAMINATE TOP				
	FN208	FN207	FN206	FN205	FN204
	LAMINATED WOOD TOP - 1 1/4"				
	FN338	FN337	FN336	FN335	FN334



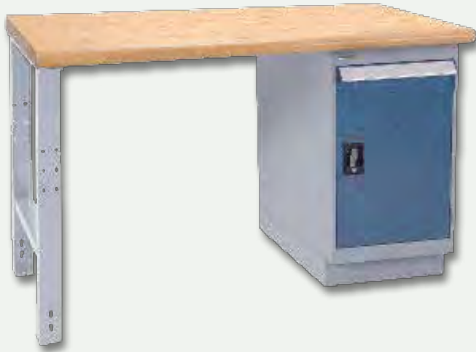

HEAVY DUTY - 2500 LBS. CAPACITY

TOPS	24" x 60"	30" x 60"	30" x 72"	36" x 60"	36" x 72"
	STEEL - WOOD FILL TOP				
	FI576	FI575	FI574	FI573	FI572
	LAMINATED WOOD TOP - 1 3/4"				
	FI581	FI580	FI579	FI578	FI577
	SHOP TOP				
	FI586	FI585	FI584	FI585	FI582
	PLASTIC LAMINATE TOP				
	FI591	FI590	FI589	FI588	FI587
	LAMINATED WOOD TOP - 1 1/4" - 1500 LBS CAPACITY				
	FN018	FN017	FN016	FN015	FN014





WORKBENCHES







INDUSTRIAL DUTY - 1000 LBS. CAPACITY, ADJUSTABLE LEGS

TOPS	24" x 60"	30" x 60"	30" x 72"	36" x 60"	36" x 72"
	STEEL - WOOD FILL TOP				
	FN213	FN210	FN211	FN210	FN209
	LAMINATED WOOD TOP - 1 3/4"				
	FN218	FN217	FN216	FN215	FN214
	SHOP TOP				
	FN223	FN222	FN221	FN220	FN219
	PLASTIC LAMINATE TOP				
	FN228	FN227	FN226	FN225	FN224
	LAMINATED WOOD TOP - 1 1/4"				
	FN343	FN342	FN341	FN340	FN339





HEAVY DUTY - 2500 LBS. CAPACITY

TOPS	24" x 60"	30" x 60"	30" x 72"	36" x 60"	36" x 72"
	STEEL - WOOD FILL TOP				
	FI596	FI595	FI594	FI593	FI592
	LAMINATED WOOD TOP - 1 3/4"				
	FI601	FI600	FI599	FI598	FI597
	SHOP TOP				
	FI606	FI605	FI604	FI603	FI602
	PLASTIC LAMINATE TOP				
	FI611	FI610	FI609	FI608	FI607
	LAMINATED WOOD TOP - 1 1/4" - 1500 LBS CAPACITY				
	FN023	FN022	FN021	FN020	FN019

INDUSTRIAL DUTY - 1000 LBS. CAPACITY, ADJUSTABLE LEGS

TOPS	24" x 60"	30" x 60"	30" x 72"	36" x 60"	36" x 72"
	STEEL - WOOD FILL TOP				
	FN233	FN232	FN231	FN230	FN229
	LAMINATED WOOD TOP - 1 3/4"				
	FN238	FN237	FN236	FN235	FN234
	SHOP TOP				
	FN243	FN242	FN241	FN240	FN239
	PLASTIC LAMINATE TOP				
	FN248	FN247	FN246	FN245	FN244
	LAMINATED WOOD TOP - 1 1/4"				
	FN348	FN347	FN346	FN345	FN344





HEAVY DUTY - 2500 LBS. CAPACITY

TOPS	24" x 60"	30" x 60"	30" x 72"	36" x 60"	36" x 72"
	STEEL - WOOD FILL TOP				
	FI616	FI615	FI614	FI613	FI612
	LAMINATED WOOD TOP - 1 3/4"				
	FI621	FI620	FI619	FI618	FI617
	SHOP TOP				
	FI626	FI625	FI624	FI623	FI622
	PLASTIC LAMINATE TOP				
	FI631	FI630	FI629	FI628	FI627
	LAMINATED WOOD TOP - 1 1/4" - 1500 LBS CAPACITY				
	FN028	FN027	FN026	FN025	FN024







WORKBENCHES

INDUSTRIAL DUTY - 1000 LBS. CAPACITY, ADJUSTABLE LEGS

TOPS	24" x 60"	30" x 60"	30" x 72"	36" x 60"	36" x 72"
	STEEL - WOOD FILL TOP				
	FN253	FN252	FN251	FN250	FN249
	LAMINATED WOOD TOP - 1 3/4"				
	FN258	FN257	FN256	FN255	FN254
	SHOP TOP				
	FN263	FN262	FN261	FN260	FN259
	PLASTIC LAMINATE TOP				
	FN268	FN267	FN266	FN265	FN264
	LAMINATED WOOD TOP - 1 1/4"				
	FN353	FN352	FN351	FN350	FN349

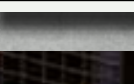

HEAVY DUTY - 2500 LBS. CAPACITY

TOPS	24" x 60"	30" x 60"	30" x 72"	36" x 60"	36" x 72"
	STEEL - WOOD FILL TOP				
	FI636	FI635	FI634	FI633	FI632
	LAMINATED WOOD TOP - 1 3/4"				
	FI641	FI640	FI639	FI638	FI637
	SHOP TOP				
	FI646	FI645	FI644	FI643	FI642
	PLASTIC LAMINATE TOP				
	FI651	FI650	FI649	FI648	FI651
	LAMINATED WOOD TOP - 1 1/4" - 1500 LBS CAPACITY				
	FN033	FN032	FN031	FN030	FN029







WORKBENCHES

HEAVY DUTY - 2500 LBS. CAPACITY

TOPS	24" x 60"	30" x 60"	30" x 72"	36" x 60"	36" x 72"
	STEEL - WOOD FILL TOP				
	F1656	F1655	F1654	F1653	F1652
	LAMINATED WOOD TOP - 1 3/4"				
	F1661	F1660	F1659	F1658	F1657
	SHOP TOP				
	F1666	F1665	F1664	F1663	F1662
	PLASTIC LAMINATE TOP				
	F1671	F1670	F1669	F1668	F1667
	LAMINATED WOOD TOP - 1 1/4" - 1500 LBS CAPACITY				
	FN038	FN037	FN036	FN035	FN034



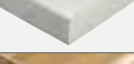



HEAVY DUTY - 2500 LBS. CAPACITY

TOPS	24" x 60"	30" x 60"	30" x 72"	36" x 60"	36" x 72"
	STEEL - WOOD FILL TOP				
	F1676	F1675	F1674	F1673	F1672
	LAMINATED WOOD TOP - 1 3/4"				
	F1681	F1680	F1679	F1678	F1677
	SHOP TOP				
	F1686	F1685	F1684	F1683	F1682
	PLASTIC LAMINATE TOP				
	F1691	F1690	F1689	F1688	F1687
	LAMINATED WOOD TOP - 1 1/4" - 1500 LBS CAPACITY				
	FN043	FN042	FN041	FN042	FN039

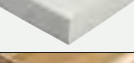

HEAVY DUTY - 2500 LBS. CAPACITY

TOPS	24" x 60"	30" x 60"	30" x 72"	36" x 60"	36" x 72"
	STEEL - WOOD FILL TOP				
	F1696	F1695	F1694	F1693	F1692
	LAMINATED WOOD TOP - 1 3/4"				
	F1701	F1700	F1699	F1698	F1697
	SHOP TOP				
	F1706	F1705	F1704	F1703	F1702
	PLASTIC LAMINATE TOP				
	F1711	F1710	F1709	F1708	F1707
	LAMINATED WOOD TOP - 1 1/4" - 1500 LBS CAPACITY				
	FN048	FN047	FN046	FN045	FN044





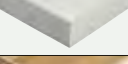

WORKBENCHES

HEAVY DUTY - 2500 LBS. CAPACITY

TOPS	24" x 60"	30" x 60"	30" x 72"	36" x 60"	36" x 72"
	STEEL - WOOD FILL TOP				
	FG137	FG136	FG135	FG134	FG132
	LAMINATED WOOD TOP - 1 3/4"				
	FG123	FG122	FG121	FG120	FG118
	SHOP TOP				
	FG144	FH901	FG142	FG141	FH902
	PLASTIC LAMINATE TOP				
	FG130	FH903	FG128	FG127	FH904
	LAMINATED WOOD TOP - 1 1/4" - 1500 LBS CAPACITY				
	FM982	FM981	FM980	FM979	FM978





HEAVY DUTY - 2500 LBS. CAPACITY

TOPS	24" x 60"	30" x 60"	30" x 72"	36" x 60"	36" x 72"
	STEEL - WOOD FILL TOP				
	FG245	FG244	FG243	FG242	FG241
	LAMINATED WOOD TOP - 1 3/4"				
	FG237	FG236	FG235	FG234	FG233
	SHOP TOP				
	FG248	FH905	FG247	FG246	FH906
	PLASTIC LAMINATE TOP				
	FG240	FH907	FG239	FG238	FH908
	LAMINATED WOOD TOP - 1 1/4" - 1500 LBS CAPACITY				
	FM987	FM986	FM985	FM984	FM983





HEAVY DUTY - 2500 LBS. CAPACITY

TOPS	24" x 60"	30" x 60"	30" x 72"	36" x 60"	36" x 72"
	STEEL - WOOD FILL TOP				
	FG468	FG467	FG466	FG465	FG464
	LAMINATED WOOD TOP - 1 3/4"				
	FG463	FG462	FG461	FG460	FG459
	SHOP TOP				
	FH914	FG471	FG470	FH913	FG469
	PLASTIC LAMINATE TOP				
	FH916	FG474	FG473	FH915	FG472
	LAMINATED WOOD TOP - 1 1/4" - 1500 LBS CAPACITY				
	FM997	FM996	FM995	FM994	FM993







WORKBENCHES

HEAVY DUTY - 2500 LBS. CAPACITY

TOPS	24" x 60"	30" x 60"	30" x 72"	36" x 60"	36" x 72"
	STEEL - WOOD FILL TOP				
	FG628	FG627	FG626	FG625	FG624
	LAMINATED WOOD TOP - 1 3/4"				
	FG623	FG622	FG621	FG620	FG619
	SHOP TOP				
	FH910	FG631	FG630	FH909	FG629
	PLASTIC LAMINATE TOP				
	FH912	FG634	FG633	FH911	FG632
	LAMINATED WOOD TOP - 1 1/4" - 1500 LBS CAPACITY				
	FM992	FM991	FM990	FM989	FM988







HEAVY DUTY - 2500 LBS. CAPACITY

TOPS	24" x 60"	30" x 60"	30" x 72"	36" x 60"	36" x 72"
	STEEL - WOOD FILL TOP				
	FG225	FG226	FG227	FG228	FG229
	LAMINATED WOOD TOP - 1 3/4"				
	FG217	FG218	FG219	FG220	FG221
	SHOP TOP				
	FH918	FG230	FG231	FH917	FG232
	PLASTIC LAMINATE TOP				
	FH920	FG222	FG223	FH919	FG224
	LAMINATED WOOD TOP - 1 1/4" - 1500 LBS CAPACITY				
	FM998	FM999	FN001	FN002	FN003



HEAVY DUTY - 2500 LBS. CAPACITY

TOPS	24" x 60"	30" x 60"	30" x 72"	36" x 60"	36" x 72"
	STEEL - WOOD FILL TOP				
	FG411	FG412	FG413	FG414	FG415
	LAMINATED WOOD TOP - 1 3/4"				
	FG416	FG417	FG418	FG419	FG420
	SHOP TOP				
	FH922	FG421	FG422	FH921	FG423
	PLASTIC LAMINATE TOP				
	FH924	FG424	FG425	FH923	FG426
	LAMINATED WOOD TOP - 1 1/4" - 1500 LBS CAPACITY				
	FN004	FN005	FN006	FN007	FN008



**CUSTOMIZE YOUR OWN WORKBENCH.
SIMPLY SELECT ANY TWO CABINETS THEN
ADD A TOP FROM THE FOLLOWING PAGE.**

MODU-BENCH WORKBENCHES

PEDESTAL STYLES

- All-welded heavy-gauge steel
- 100% full extension drawers with ball bearing slide mechanism
- Reversible doors, can be opened on either left or right side (factory installed hinges on right side)
- Aluminum extrusion handles with grey end caps
- Complete with locks and two keys
- All locks keyed alike for pedestal model
- Custom key options available
- 18" W x 21" D x 28" H, overall cabinet size
- 30" overall height with top
- Optional bases add height in 4" increments (maximum two bases per pedestal)
- Capacity: 100 lbs. per drawer evenly distributed
- Powder coat finish with grey Kleton shell and Kleton blue on doors and drawers



FULL DOOR

16-3/4" W x 21" D x 24" H
Internal Adjustable
Shelf included
Weight: 50 lbs.
Model No. **FH666**



TWO DOORS

(2) 16-3/4" W x 21" D x 12" H
Weight: 48 lbs.
Model No. **FH667**



TWO DRAWERS & ONE DOOR

(2) 15-3/8" W x 20" D x 5-5/8" H
(1) 16-3/4" W x 21" D x 12" H
Weight: 70 lbs.
Model No. **FH668**



TWO DRAWERS

(2) 15-3/8" W x 20" D x 11-5/8" H
Weight: 66 lbs.
Model No. **F1166**



THREE DRAWERS

(2) 15-3/8" W x 20" D x 5-5/8" H
(1) 15-3/8" W x 20" D x 11-5/8" H
Weight: 78 lbs.
Model No. **F1167**



FOUR DRAWERS

(4) 15-3/8" W x 20" D x 5-5/8" H
Weight: 68 lbs.
Model No. **FH669**



FOUR DRAWERS & ONE DOOR

(4) 15-3/8" W x 20" D x 2-5/8" H
(1) 16-3/4" W x 21" D x 12" H
Weight: 86 lbs.
Model No. **FH670**



SIX DRAWERS

(4) 15-3/8" W x 20" D x 2-5/8" H
(2) 15-3/8" W x 20" D x 5-5/8" H
Weight: 94 lbs.
Model No. **FH671**



BASE

4" High - 34" high with top
Weight: 8 lbs.
Model No. **FH672**

LEG AND PEDESTAL COMBINATIONS

- All-welded 14-gauge steel legs
- Knockout for standard two-outlet electrical plug
- Overall height of 34" with top
- Powder coat Kleton grey finish

Model No.	Description	Dimensions D" x H"	Wt. lbs.
ML264	Single Leg for Use w/ 24"D Top	22 x 32	14
ML265	Single Leg for Use w/ 30"D or 36" D Top	28 x 32	15
FH672	Pedestal Base (Max 1)*	4" H	5
FF920	Bench Leg Gussets (Pkg. of 2)*	-	3
M0931	Single leg for use w/ 24"D top		8
M0932	Single leg for use w/ 30"D or 36"D top		8

* Pedestal base and bench leg gussets are required components when building all leg/pedestal combinations

HOW TO ORDER

1. Choose the pedestal and leg combination desired
 2. Choose your desired top
- See our selection of workbench tops on Page 76.

We try to make it easy...
look at our pre-designed layout
options on pages 65 - 74.

Customize to your specifications. If you need specific sizes
or requirements not available on this page... call your
Kleton dealer with your specs today!



MODU-BENCH WORKBENCHES

CUSTOMIZE YOUR WORKBENCHES WITH ANY OF THE FOLLOWING OPTIONS.



LAMINATED HARDWOOD TOPS - SQUARE EDGE

- Lacquer finished tops for durability
- Heavy-duty solid hardwood laminations for long life
- Overall thickness: 1-3/4"
- 1/8" radius edge
- Tops over 36" deep are shipped in two pieces

Model No.	Dimensions D" x W"	Wt. lbs.	Model No.	Dimensions D" x W"	Wt. lbs.
FI730	24 x 48	56	FL596	36 x 48	84
FL592	24 x 60	70	FL597	36 x 60	105
FL593	24 x 72	84	FI738	36 x 72	126
FI731	24 x 84	98	FL598	36 x 84	147
FL594	24 x 96	112	FI739	36 x 96	168
FI732	24 x 120	140	FL599	36 x 120	210
FL595	30 x 48	70	FI740	48 x 48	112
FI733	30 x 60	88	FL600	48 x 60	140
FI734	30 x 72	105	FL601	48 x 72	168
FI735	30 x 84	123	FL602	48 x 84	196
FI736	30 x 96	140	FL603	48 x 96	224
FI737	30 x 120	175	FL604	48 x 120	280



LAMINATED HARDWOOD TOPS - BULLNOSE EDGE

- 3/8" radius edge
- Lacquer finished tops for durability
- Heavy-duty solid hardwood laminations for long life
- Overall thickness: 1-3/4"
- Tops over 36" deep are shipped in two pieces.

Model No.	Dimensions D" x W"	Wt. lbs.	Model No.	Dimensions D" x W"	Wt. lbs.
FI522	24 x 48	56	FL607	36 x 48	84
FI523	24 x 60	70	FI532	36 x 60	105
FI524	24 x 72	84	FI533	36 x 72	126
FL605	24 x 84	98	FL608	36 x 84	147
FI525	24 x 96	112	FI534	36 x 96	168
FI526	24 x 120	140	FL609	36 x 120	210
FI527	30 x 48	70	FL610	48 x 48	112
FI528	30 x 60	88	FL611	48 x 60	140
FI529	30 x 72	105	FL612	48 x 72	168
FI530	30 x 84	123	FL613	48 x 84	196
FI531	30 x 96	140	FL614	48 x 96	224
FL606	30 x 120	175	FL615	48 x 120	280



THIN LAMINATED HARDWOOD TOPS - BULLNOSE EDGE

- Lacquer finished tops for durability
- Industrial-duty solid hardwood laminations for long life
- Overall thickness: 1-1/4"
- 1/8" radius edge
- Tops over 36" deep are shipped in two pieces

BULL NOSE EDGE

Model No.	Dimensions D" x W"	Wt. lbs.	Model No.	Dimensions D" x W"	Wt. lbs.
FM930	24 x 48	33	FM937	24 x 48	33
FM931	24 x 60	41	FM938	24 x 60	41
FM932	24 x 72	50	FM939	24 x 72	50
FM933	30 x 48	42	FM940	30 x 48	42
FM934	30 x 60	53	FM941	30 x 60	53
FM935	30 x 72	64	FM942	30 x 72	64
FN369	36 x 60	75	FN370	36 x 60	75
FM936	36 x 72	77	FM943	36 x 72	77

SQUARE EDGE

Model No.	Dimensions D" x W"	Wt. lbs.	Model No.	Dimensions D" x W"	Wt. lbs.
FM930	24 x 48	33	FM937	24 x 48	33
FM931	24 x 60	41	FM938	24 x 60	41
FM932	24 x 72	50	FM939	24 x 72	50
FM933	30 x 48	42	FM940	30 x 48	42
FM934	30 x 60	53	FM941	30 x 60	53
FM935	30 x 72	64	FM942	30 x 72	64
FN369	36 x 60	75	FN370	36 x 60	75
FM936	36 x 72	77	FM943	36 x 72	77



SHOP TOPS

- Great top for medium-duty applications
- 1/2" double sealed resin boards laminated over 3/4" MDF core
- Overall thickness: 1-3/4"

Model No.	Dimensions D" x W"	Wt. lbs.
FD001	24 x 48	60
FD002	24 x 60	75
FH764	30 x 48	75
FD004	30 x 60	94
FD005	30 x 72	113
FH765	30 x 84	131
FH766	30 x 96	150
FD006	36 x 48	90
FD007	36 x 60	113
FD007	36 x 72	135
FH768	36 x 84	158
FH769	36 x 96	180



PLASTIC LAMINATE TOPS

- Light-duty top with smooth white plastic laminate face covering 45-lb. density particle board
- Overall thickness: 1-5/8"
- Colour: White

Model No.	Dimensions D" x W"	Wt. lbs.
FD008	24 x 48	65
FD009	24 x 60	72
FH771	30 x 48	72
FD011	30 x 60	90
FD012	30 x 72	108
FH772	30 x 84	126
FH773	30 x 96	144
FH774	36 x 48	86
FD013	36 x 60	108
FD014	36 x 72	130
FH776	36 x 84	151
FH777	36 x 96	173

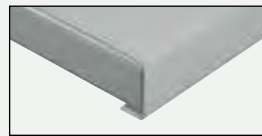

STEEL WOOD-FILLED TOPS

- Heavy-duty 14-gauge steel with formed edges
- Reinforced with wood core for sound reduction and added strength
- Overall thickness: 1-3/4"
- Colour: Powder coat Kleton grey

Model No.	Dimensions D" x W"	Wt. lbs.
FD030	24 x 48	59
FD031	24 x 60	74
FH871	30 x 48	74
FD033	30 x 60	92
FD034	30 x 72	110
FH872	30 x 84	129
FH873	30 x 96	147
FH874	36 x 48	89
FD035	36 x 60	110
FD036	36 x 72	132
FH875	36 x 84	154
FH876	36 x 96	176

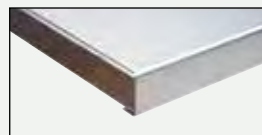

304 STAINLESS STEEL WOODFILLED TOPS

- Heavy-duty 14-gauge stainless steel with a number 4 finish and formed edges
- Reinforced with wood core for sound reduction and added strength
- Overall thickness: 1-3/4"

Model No.	Dimensions D" x W"	Wt. lbs.
FI268*	24 x 48	59
FI269*	24 x 60	74
FI270*	30 x 48	74
FI271*	30 x 60	92
FI272*	30 x 72	110
FI273*	30 x 84	129
FI274*	30 x 96	147
FI275*	36 x 48	89
FI276*	36 x 60	110
FI277*	36 x 72	132
FI278*	36 x 84	154
FI279*	36 x 96	176

* Stainless Steel finish may vary

CUSTOMIZE YOUR WORKBENCHES WITH ANY OF THE FOLLOWING OPTIONS.

MODU-BENCH WORKBENCHES

CREATE A WORKBENCH DESIGNED FOR YOUR APPLICATION

- Select from the components below to build the workbench to fit your needs.
- All components required to make up your workbench are on this page
- Optional features for enhanced functionality are on the following page
- All steel components constructed of 14-gauge steel unless otherwise specified
- All mounting hardware included
- Capacities range from 1000 lbs. to 2500 lbs.
- All steel components are powder coat KLETON grey
- Shipped knocked down

THINGS TO CONSIDER WHEN ORDERING A WORKBENCH

1. Determine the size (length, width, height) of the workbench required.
2. Select one of each of the required components listed on this page, respecting the determined size of the workbench.

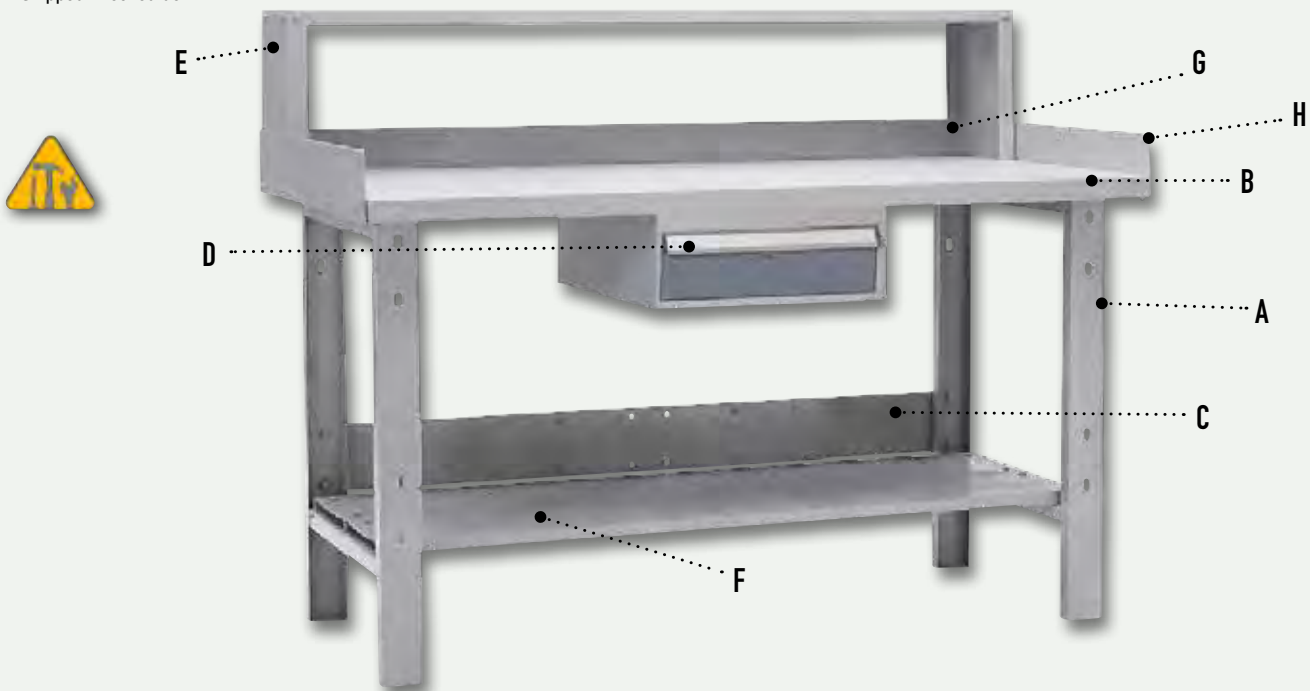

A - LEGS

- Legs static or mobile
- Comes with knockout for standard 2-outlet electrical plug
- Provides an overall height of 34" w/top



Model No.	Description	D" x H"	Wt. lbs.
HEAVY-DUTY			
ML264	Single leg for use w/ 24"D top	22 x 32	14
ML265	Single leg for use w/ 30"D or 36"D top	28 x 32	15
ML266*	Pair of legs to use w/24"D tops, includes Stringer FF979	22 x 32	38
ML268*	Pair of legs to use w/30"D or 36"D tops, includes Stringer FF979	22 x 32	40
ML267*	Mobile Kit for use w/24"D top (pair), includes Stringer FF979	28 x 32	45
ML269*	Mobile Kit for use w/30"D or 36"D top (pair), includes Stringer FF979	28 x 32	40
FG732	Leg extensions to make height adjustable from 34"-39" in 1" increments (set of 4)		8
* For 84"L and 96"L tops, FH925 or FH926 stringers are required			
INDUSTRIAL DUTY			
M0931	Single leg for use w/ 24"D top		8
M0932	Single leg for use w/ 30"D or 36"D top		8

CUSTOMIZE YOUR WORKBENCHES WITH ANY OF THE FOLLOWING OPTIONS.

MODU-BENCH WORKBENCHES

B - TOPS

A variety of tops are available. 14-gauge steel wood filled, laminated wood, shop top and plastic laminate in a variety of sizes. Our complete list of tops can be found on Page 76.

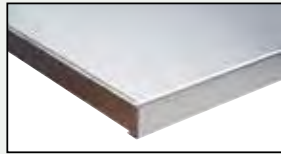

Stainless-Steel Wood-Filled Top



Wood Top



Bullnose- Wood Top



Thin Wood Top

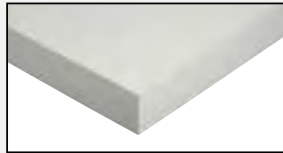

Plastic Laminate Top



Shop Top



Steel Wood-Filled Top

C - STRINGERS

- Adds stability to the workbench
- Prevents legs from shifting
- Included in kits **ML266** to **ML269**
- Weight: 11lbs.



FF979



M0936

HEAVY-DUTY UNIVERSAL STRINGERS

Model No. **FF979** - for 48", 60" or 72" bench

Model No. **FH925** - for 84" bench

Model No. **FH926** - for 96" bench

INDUSTRIAL DUTY UNIVERSAL STRINGER

Model No. **M0936** - for 48", 60" or 72" bench

D - DRAWERS

- All-welded heavy-gauge steel
- Add storage to any workbench
- 100% full extension with ball bearing slide mechanism
- Equipped with locks and two keys
- All locks keyed alike by drawer model
- Custom key options available
- Capacity: 100 lbs. per drawer evenly distributed
- Aluminum extrusion handles with grey end caps
- Overall Dimensions: 18" W x 21" D x 9" H



SINGLE DRAWER UNITS

Model **FH673**

(1) 15-3/8" W x 20" D x 5-5/8" H



DOUBLE DRAWER UNITS

Model **FH674**

(2) 15-3/8" W x 20" D x 2-3/4" H

CUSTOMIZE YOUR WORKBENCHES WITH ANY OF THE FOLLOWING OPTIONS.

MODU-BENCH WORKBENCHES

E - BENCH RISER SHELVES

- Increase storage space
- Ideal for getting tools and other equipment off work surfaces
- 9" D x 12" H
- One per workbench



Model No.	Overall Width"	Wt. lbs.
FF956	48	19
FF957	60	24
FF958	72	29
FI319	84	35
FI320	96	42

F - LOWER SHELVES

- Add extra storage to any workbench

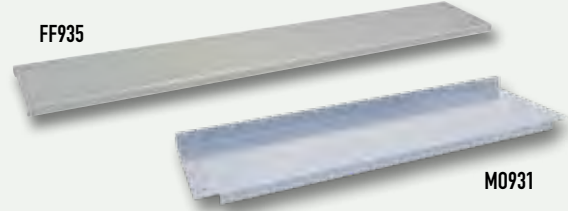

Model No.	Overall Width"	Wt. lbs.
HEAVY-DUTY (One or two 9" deep shelves can be used per workbench)		
FF934	44 (For Use with 48" Top)	14
FF935	56 (For Use with 60" Top)	16
FF936	68 (For Use with 72" Top)	18
RL866	80 (For Use with 84" Top)	21
RL867	92 (For Use with 96" Top)	24
INDUSTRIAL DUTY (One 14 3/4" deep shelf can be used per workbench)		
M0933	48 (For Use with 48" Top)	12
M0934	60 (For Use with 60" Top)	15
M0935	72 (For Use with 72" Top)	18

G - BACK STOPS

- Add a 3" edge to the back of any workbench
- One per bench top



Model No.	Overall Width"	Wt. lbs.
FF704	48	8
FF705	60	10
FF708	72	12
FI317	84	14
FI318	96	16

H - END STOPS

- Add 3" sides to any workbench
- One per side desired to enclose



Model No.	Overall Depth"	Wt. lbs.
FF792	24	4
FF793	30	5
FF794	36	6

STAINLESS STEEL TOP WORKBENCHES

- Top constructed of 14-gauge stainless steel with a number 4 finish and formed edges
- Top reinforced with wood core for sound reduction and added strength
- 1-3/4" overall thickness
- Overall dimensions: 72" W x 30" D x 34" H
- Legs and stringers are constructed from 14-gauge steel powder coated Kleton grey finish
- Capacity: 2500 lbs. evenly distributed

Model No. **FI296**



MOBILE WORKBENCHES

Customize KLETON products to your specs!
See Inside Front Cover



MOBILE CABINET BENCHES

- Mount one, two or three cabinets from six choices of cabinets
- Heavy-duty 11-gauge steel base, 1-1/4" thick laminated hardwood top, and a push handle
- Four 5" non-marking casters with brakes for smooth, easy rolling
- Doors are reversible, can be opened either left or right side
- All locks keyed alike by pedestal model
- Cabinet frame powder coat finish with grey shell and KLETON blue on doors and drawers
- Shipped knocked down



1200 - LB. CAPACITY
Evenly Distributed

CONFIGURE YOUR OWN UNIT BY CHOOSING:

1. The pedestal style(s) that suits your needs (to a maximum of three pedestal(s))
2. Add to that the assembly kit, whether it be single, double or triple.
Assembly kit includes casters, base and 1-1/4" laminated hardwood top.



1 - PEDESTAL STYLES - COMPLETE WITH LOCK AND TWO KEYS

Model No.	Description	Wt. lbs.
FH666	One door	51
FH667	Two half doors	52
FH668	Two small drawers and one half door	75
F1166	Two large drawers	66
F1167	Two small drawers and one large drawer	78
FH669	Four large drawers	97
FH670	Four small drawers and one half door	84
FH671	Four small drawers and two large drawers	98



2 - ASSEMBLY KITS

Model No.	Description	Wt. lbs.
FH407	Single	35
FH408	Double	65
FH409	Triple	95

SINGLE PEDESTAL BENCHES

- Heavy gauge steel cabinet with 1" round tube frame
- Top tray lined with a rubber mat
- Full extension drawers with a capacity of 100 lbs. per drawer
- Four 4" non-marking casters with brakes for smooth, easy rolling
- Comes complete with locks and two keys
- Overall dimensions 20" W x 21" D x 37" H
- Cabinet frame powder coat finish with grey shell and KLETON blue on doors and drawers

800 - LB. CAPACITY
Evenly Distributed



Model No.	Description	Wt. lbs.
FF984	4-Drawer cabinet	120
MH801	Single door cabinet	75



Customize KLETON
products to your specs!
See Inside Front Cover

MOBILE WORKBENCHES

MOBILE TOOL BOX BENCHES

- A versatile unit combining tool/storage area with a work surface
- Heavy-duty 11-gauge steel top and base
- Four - 5" non-marking casters: two rigids and two swivels with brake
- Overall dimensions: 60" W x 22" D x 37" H
- Durable Kleton blue enamel finish

Model No.	Description	Wt. lbs.
FF993	5 Drawers/3 Drawers	285
FF994	3 Drawers and side Shelves	220
FF995	5 Drawers and side Shelves	235

3-DRAWER CABINET WITH FLIP TOP PANEL

- 1 x drawer - 22-1/8" W x 16-3/4" D x 2" H
- 2 x drawers - 22-1/8" W x 16-3/4" D x 4" H
- 3 x drawers - 26-1/2" W x 18" D x 12-3/8" H
- Colour: Red

5-DRAWER CABINET

- 1 x drawer - 22-1/8" W x 16-3/4" D x 2" H
- 2 x drawers - 22-1/8" W x 16-3/4" D x 4" H
- 2 x drawers - 22-1/8" W x 16-3/4" D x 6-1/8" H
- Colour: Red

FF993



FF994

**1200 - LB.
CAPACITY**
Evenly Distributed

INDUSTRIAL-DUTY MOBILE SERVICE BENCHES

- 16-gauge all-welded steel construction
- Designed for moving heavy parts and tools to the job site
- Provides a strong maintenance-free surface to work on
- Laminated hardwood top
- Four - 5" non-marking casters:
two rigids and two swivels with brake
- Overall dimensions: 42" W x 24" D x 37" H
- Shell durable Kleton blue enamel finish
- Cabinets are powder coat paint grey and KLETON blue
- Shipped assembled

**1200 - LB.
CAPACITY**
Evenly Distributed

Model No.	Description	Wt. lbs.
ML325	2 Doors	235
ML326	1 Drawer/1 Door	190
ML327	4 Drawers/1 Door	275
ML328	8 Drawers	300



ML325



ML326



ML327



ML328

MAXI-BENCH WORKSTATIONS

- Roll your workstation to your work area
- All-welded 14-gauge frame with 30" x 60" steel wood-filled top
- Comes with 5" nylon non-marking casters, two rigid and two swivel with brakes
- Includes: 42" H peg board panel, double drawers, swivel-out stool, lower shelf, end stops
- Models FF068 (shown) and FF071 include fluorescent lamp, 25' incandescent drop light and 4-outlet power bar
- Durable KLETON blue enamel finish

Model No.	Description	Overall Height"	Wt. lbs.
FF068	Mobile, Complete	76	435
FF069	Mobile, No Electrical	76	415
FF071	Static, Complete	70	425
FF072	Static, No Electrical	70	405

**1200 - LB.
CAPACITY**
Evenly Distributed

FF068



CABINET WORKBENCHES

Customize KLETON products to your specs!
See Inside Front Cover

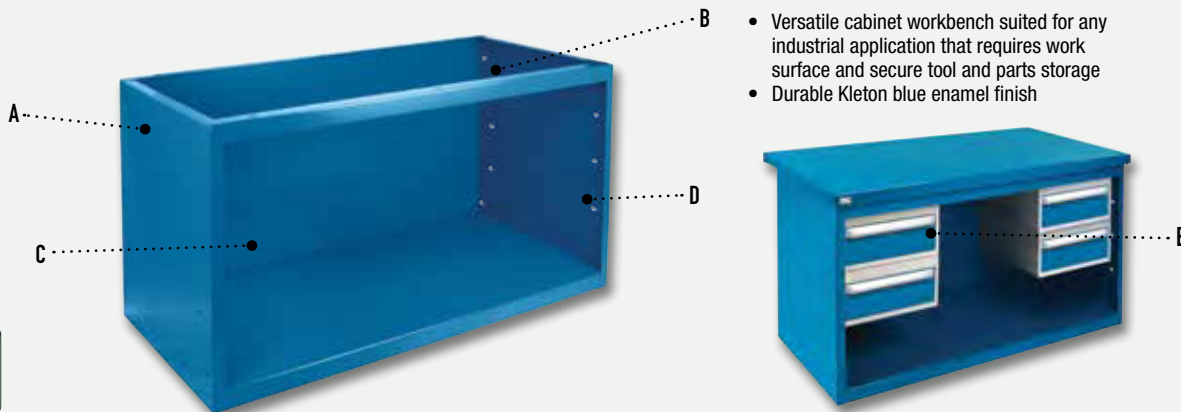

- Versatile cabinet workbench suited for any industrial application that requires work surface and secure tool and parts storage
- Durable Kleton blue enamel finish

1000 - LB. CAPACITY
Evenly Distributed

A - CABINET SHELL ONLY

- Made of all-welded 14-gauge steel



Model No.	Dimensions L" x W" x H"	Wt. lbs.
FH165	28 x 59 x 32	105

B - TOPS

- Our complete list of tops can be found on page 76.



Steel Wood-Filled



Laminated Wood



Plastic Laminate



Shop Top



Laminated Wood Bullnose Edge



Stainless Steel Wood-Filled

Material	30" x 60"	30" x 72"	36" x 60"	36" x 72"
Steel Wood Filled (Grey)	FD033	FD034	FD035	FD036
Steel Wood Filled (Blue)	FH183	FH184	FH185	FH186
Laminated Wood	FI733	FI734	FI532	FI738
Plastic Laminated	FD011	FD012	FD013	FD014
Shop Top	FD004	FD005	FD006	FD007
Wood Bullnose Edge	FI528	FI529	FI532	FI533
Stainless Wood-Filled	FI271	FI272	FJ882	FI277

C - SHELF

- Made of 14-gauge steel
- Maximum two per cabinet
- Capacity: 300 lbs.



Model No.	Dimensions L" x W"	Wt. lbs.
FH164	27-3/4 x 58-3/4	15

D - DOOR

- Made of 18-gauge steel on rollers
- Recessed handles
- Includes: Plunger lock and two keys



Model No.	Dimensions	Wt. lbs.
FH163	Door Set, Lock Included	40

E - DRAWERS

- All-welded heavy gauge steel
- 100% full extension with ball bearing slide mechanism
- All locks keyed alike by drawer model
- Includes: Locks and two keys
- Aluminum extrusion handles with grey end caps
- Capacity: 100 lbs. per drawer evenly distributed



Model No.	Drawer Dimensions L" x W" x H"	Wt. lbs.
FH938	15-3/8 x 20 x 5-5/8	30
FH939	15-3/8 x 20 x 2-3/4	35



Customize KLETON
products to your specs!
See Inside Front Cover

HEAVY-DUTY WORKBENCHES

HEAVY-DUTY MACHINE STANDS

- All-welded construction
- Designed for use as a machinery stand or work table when full workbench is not necessary
- 14-gauge steel lip-down shelves, with bolt down foot plates on 3/16" x 1-1/2" angle leg
- Overall Height: 32"
- Durable Kleton blue enamel finish

**1200-LB.
CAPACITY**



Model No.	Dimensions W" x D" x H"	Shelf Clearance"	Capacity lbs.	Wt. lbs.
FH268	30 x 18 x 32	14	1200	60
FH269	36 x 24 x 32	14	1200	70
FH270	48 x 24 x 32	14	1200	85

EXTRA HEAVY-DUTY WORKBENCHES

- Our most solid workbench available with 11-gauge steel legs and stringers
- All-welded construction features a wood-filled 3/16" steel top
- Standard bolt-down foot plates
- Mobile unit has 6" phenolic casters, two swivel with brake and two rigid
- Overall height: 34"
- Durable Kleton blue enamel finish

**3500 - 5000 - LB.
CAPACITY**
Evenly Distributed



Model No.	Style	Dimensions W" x D" x H"	Capacity lbs.	Wt. lbs.
FF494	Static	72 x 30 x 34	5000	290
FF495	Static	72 x 36 x 34	5000	360
FH465	Mobile	72 x 30 x 34	3500	290
FH466	Mobile	72 x 36 x 34	3500	360

PEDESTAL BENCHES

- Designed for workshop applications
- 1 3/4" thick solid laminated hard wood top mounted on two all-welded pedestals with two shelves each
- Pedestals are 18" W x 24" D x 32" H
- Overall height: 34"
- Durable Kleton blue enamel finish

**2500-LB.
CAPACITY**

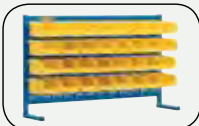

Please see page 120 for Louvered Bin Racks that can be added to Heavy-Duty Work Benches or Pedestal Benches

Model No.	Dimensions W" x D" x H"	Wt. lbs.
FF120	60 x 30 x 34	158
FF121	72 x 30 x 34	175
FF122	84 x 30 x 34	192
FF119	120 x 30 x 34	245

INDIVIDUAL PEDESTALS

FF127	18 x 24 x 32	42
-------	--------------	----



FOLDING TABLES

POLYETHYLENE FOLDING TABLES

- Blow molded polyethylene top
- Lightweight with folding legs for easy storage
- 29" fixed table height with locking steel legs
- Easy to clean
- Folding legs automatically lock by use of gravity activated mechanism when opened
- Top thickness: 1-5/8"
- Capacity: 500 lbs.



Model No.	Dimensions L" x W" x H"	Wt. lbs.
ON598	48 x 24 x 29	22
ON599	72 x 30 x 29	35
ON600	96 x 30 x 29	50

POLYETHYLENE FOLD-IN-HALF TABLES

- Blow-molded polyethylene top
- Lightweight with ability to fold the table in half to 3-1/2" thick for easy storage
- 29" fixed table height with locking steel legs
- Folding legs automatically lock by use of gravity activated mechanism when opened
- Easy to clean
- Dimensions: 72" L x 30" W x 29" H
- Top thickness: 1-5/8"
- Weight: 36 lbs
- Capacity: 350 lbs.

Model No. **ON601**



ROUND POLYETHYLENE FOLDING TABLE

- Folding legs automatically lock by use of gravity-activated mechanism when opened
- Lightweight with folding legs for easy storage
- Blow-molded high-density polyethylene top
- Top thickness: 2"
- Capacity: 395 lbs.



Model No.	Dimensions L" x W" x H"	Wt. lbs.	Seats
Q0320	48 x 48 x 29	15	6-8 People
Q0321	60 x 60 x 29	20	8-10 People

SQUARE POLYETHYLENE FOLDING TABLE

- Lightweight with folding legs for easy storage
- Blow-molded polyethylene top
- Easy to clean
- Seats four people
- Dimensions: 34" W x 34" L x 29" H
- Top thickness: 1-3/4"
- Weight: 20 lbs
- 250 lbs Capacity

Model No. **Q0714**



FOLDING CHAIRS & BENCHES

POLYETHYLENE FOLDING CHAIRS

- Durable contoured back and seat for all day comfort
- Steel framing and folding legs for extra strength
- Easy to clean
- Dimensions: 16-1/2" D x 18-3/4" W x 35" H
- Capacity : 350 lbs.

Model No.	Colour
ON602	White
OP448	Black
OP449	Blue



STEEL FOLDING CHAIRS

- Foldable frame for easy storing
- Steel construction makes cleaning quick and easy
- Dimensions: 18" W x 15-3/4" D x 30-1/2" H
- Capacity : 300 lbs.

Model No.	Seat Type	Colour
OP960	Steel	Black
OP961	Steel	Beige
OP962	Padded	Black
OP963	Padded	Beige



DOUBLE-SIDED FOLDING CHAIR CADDY

- Holds up to 72 of the **OP448**, **OP449** and **ON602** polyethylene folding chairs OR up to 84 of the **OP963** steel folding chairs
- Easy to maneuver with 4", non-marking, blue, rubber swivel casters
- All-welded steel construction arrives ready to use
- Dimensions: 35-1/2" W x 64-1/2" L x 73" H

Model No. **OQ768**



POLYETHYLENE FOLDING BENCH

- Durable high-density polyethylene construction
- Steel framing and folding legs for extra strength
- Dimensions: 72" L x 12" W x 17" H
- Folded dimensions: 36" L x 12" W x 4" H
- Weight: 20 lbs.

Model No. **ON699**



CORK BOARDS & WHITE BOARDS



CORK BOARDS

- Ideal for office or warehouse environments
- Sturdy aluminum frame
- Plastic-molded corners protect the board and wall from damage
- Double-sided cork for added durability

Model No.	Dimensions"	Wt. lbs.
ON593	18 x 24	3.5
ON594	24 x 36	6
ON595	36 x 48	10.5
ON596	48 x 72	18
ON597	48 x 96	30



COMBINATION CORK/WHITE BOARDS

- Dual-purpose cork/white board provides versatility in getting your message across
- Dimensions: 24" x 36"
- Weight: 8 lbs.
- Porcelain whiteboard for a smooth and clear writing surface
- Double-sided cork for added durability
- Ideal for office or warehouse environments
- Plastic-molded corners protect the boards and wall from damage
- Sturdy aluminum frame
- Features a removable marker tray
- Can be hung vertically or horizontally

Model No. **OP542**

CORKBOARD PUSH PINS

- Plastic head, assorted colours. 100/pkg.
- Price per package

Model No. **OJ472**



HEAVY-DUTY STEEL STEP STOOL

- Comes with a double platform with non-slip rubber tread
- Spring-loaded casters retract under slight pressure, forcing base to the floor
- 11" diameter upper platform and 13-1/2" diameter lower platform
- 17-1/4" diameter base has an all-around protective bumper
- 16-1/2" overall height
- Weight: 10 lbs.
- Colour: Black

Model No. **ON528**

REPLACEMENT CASTER KIT

Model No. **ON617**



WHITE BOARDS

WHITE BOARDS NON-MAGNETIC

- White writing surface provides clean, colorful display
- Effortless erasing, wipes clean with cloth or felt brush
- Aluminum frame
- Plastic corners for board and wall protection

Model No.	Dimensions H" x W"	Wt. lbs.
ON530	18 x 24	3.25
ON531	24 x 36	6
ON532	36 x 48	10.5
ON533	48 x 72	18
ON534	48 x 96	30

ON534



MAGNETIC

- White magnetic writing surface provides clean, colorful display
- Effortless erasing, wipes clean with cloth or felt brush
- Aluminum frame
- Plastic corners for board and wall protection
- Features a removable marker tray
- Can be hung vertically or horizontally

Model No.	Dimensions H" x W"	Wt. lbs.
ON535	24 x 36	6
ON536	36 x 48	10.5
ON537	48 x 72	18

MAGNETIC PORCELAIN WHITE BOARDS

- White magnetic writing surface provides a clean, colourful display
- Porcelain surface is smooth and resistant to staining
- Effortless erasing, wipes clean with cloth or felt brush
- Galvanized steel backing for added durability
- Plastic corners for board and wall protection
- Mounting hardware included
- Features a removable marker tray
- Can be hanged vertically or horizontally

Model No.	Dimensions H" x W"	Wt. lbs.
OP534	18 x 24	4
OP536	36 x 48	14

OP536

OP534



DURA-INK® DRY ERASE INK MARKERS

- Industrial strength felt-tip ink markers for temporary marking applications
- Mark can be removed quickly and easily with dry rag, towel, or eraser
- No residue or ghosting after mark is removed on most industrial surfaces
- Suitable for any non-porous surfaces

Markal
High Performance Industrial Markers



Model No.	Description
PE773	Red
PE774	Black
PE775	Blue
PE776	Green

SHOP DESKS & LOCKER ROOM BENCHES

CABINET STYLE SHOP DESKS



- Durable carbon steel construction
- Same features as the open floor style shop desk, with an added double door locking cabinet
- Four-compartment organizer and slightly sloped 43" height writing surface
- Optional caster kit to convert to mobile unit
- 23" W x 16" D x 3 1/2" H locking drawer on quiet nylon rollers
- Overall dimensions: 34" W x 30" D x 53" H
- Weight: 146 lbs.
- Grey enamel finish

Model No. **FI520**



OPTIONAL CASTER KIT

Model No. **FI521**



OPEN FLOOR STYLE SHOP DESKS



- Durable carbon steel construction
- Ideal for receiving/shipping clerks, watchmen and shop foremen
- Four-compartment organizer and slightly sloped 43" height writing surface
- Optional caster kit to convert to mobile unit
- 23" W x 16" D x 3-1/2" H locking drawer on quiet nylon rollers
- Overall dimensions: 34" W x 30" D x 53" H
- Weight: 93 lbs.
- Grey enamel finish

Model No. **FI519**



OPTIONAL CASTER KIT

Model No. **FI521**



WALL-MOUNTED SHOP DESKS



- Durable carbon steel construction
- Ideal for areas with limited floor space
- Four-compartment organizer and slightly sloped writing surface
- Easy to assemble, wall brackets included
- 23" W x 16" D x 3 1/2" H locking drawer on quiet nylon rollers
- Overall dimensions: 34" W x 28" D x 31" H
- Weight: 74 lbs.
- Grey enamel finish

Model No. **FI518**



LOCKER ROOM BENCHES

- 16 gauge steel all-welded
- Wood top benches feature black powder coated legs that can be used free-standing or bolted to the floor
- Necessary for any locker room
- 9-1/4" wide rounded hardwood top

Model No.	Type	Dimensions L" x W" x H"	Wt. lbs.
FB002	Steel	72 x 12 x 17	35
RL871	Wood	48 x 9-1/2 x 16-1/2	23
RL872	Wood	60 x 9-1/2 x 16-1/2	29
RL873	Wood	72 x 9-1/2 x 16-1/2	31
RL874	Wood	96 x 9-1/2 x 16-1/2	39



LADDERS, STANDS & PLATFORMS

Work Platforms	90
Step Stands	90
Tilt-N-Roll Step Stands	90
Rolling Ladders	91 - 93
Trailer Access Rolling Ladders	91
Tilt-N-Roll Ladders	93
Mechanics/Maintenance Rolling Ladders	93
Portable Folding Ladders	93
Maintenance Platforms	94

STEP STANDS & PLATFORMS

Customize KLETON products to your specs!
See Inside Front Cover



WORK PLATFORMS

- Frame is welded 1" round steel tubing
- Elevate workers to comfortable working heights
- Provides solid footing around machinery and other work areas
- Non-clogging slip-resistant steel steps
- Durable Kleton blue enamel finish
- Meets ANSI standard A14.7

800-LB. CAPACITY



Model No.	Top Step W" x D"	Top Step Height"	Wt. lbs.
VC127	24 x 32	6	28
VC128	32 x 32	6	34
VC129	24 x 32	12	32
VC130	32 x 32	12	38

REPLACEMENT PARTS

Model No. **VC055**, Rubber Foot Tip

STEP STANDS

- Frame is welded 1" round steel tubing
- Rolling stand comes with 3" spring-loaded casters
- Non-clogging slip-resistant steel steps
- Durable Kleton blue enamel finish
- Meets ANSI standard A14.7

300-LB. CAPACITY



STATIC STANDS

Model No.	Overall Dim. W" x D" x H"	Top Step W" x D"	Wt. lbs.
MH228	20 x 16 x 12	18 x 16	11
MH229	24 x 16 x 12	22 x 16	13
MH230	32 x 16 x 12	30 x 16	16

ROLLING STANDS

Model No.	Overall Dim. W" x D" x H"	Top Step W" x D"	Wt. lbs.
MH225	20 x 16 x 12	18 x 16	17
MH226	24 x 16 x 12	22 x 16	19
MH227	32 x 16 x 12	30 x 16	22

REPLACEMENT PARTS

Model No. **MA790**, Spring Loaded 3" Swivel Caster

Model No. **VC055**, Rubber Foot Tip

TILT-N-ROLL STEP STANDS

- Frame is welded 1" round steel tubing
- Handle allows step stand to move easily on two 4" casters
- Non-clogging slip-resistant steel steps
- Durable Kleton blue enamel finish
- Meets ANSI standard A14.7

300-LB. CAPACITY



Model No.	Number of Steps	Step Size W" x D"	Top Step Height"	Top Step W" x D"	Wt. lbs.	Base Dim. W" x D"
VC335	1	22 x 8	12	22 x 16	24	29 x 16
VC336	2	22 x 8	19	22 x 16	33	29 x 24



Customize KLETON products to your specs!
See Inside Front Cover

ROLLING STEP LADDERS



MA613



VC131

24" WIDE ROLLING STEP LADDERS

- Frame is welded 1" round steel tubing
- For use in record storage rooms, offices, warehouses and confined spaces
- Rolls into position and locks firmly to the floor
- Casters retract under operator's weight while rubber feet drop down
- Non-clogging slip-resistant steel steps
- Durable Kleton blue enamel finish
- CSA certified to the ANSI standard A14.7

300-LB. CAPACITY

Model No.	Number of Steps	Step Size W" x D"	Top Step Height"	Top Step W" x D"	Base Dim. W" x D"	Wt. lbs.
MA612	2	22 x 8	19	22 x 16	24 x 26	32
MA613	3	22 x 8	28	22 x 16	24 x 30	42
MH279	4	22 x 8	37	22 x 16	24 x 37	52
MA615	5	22 x 8	46	22 x 16	24 x 41	61

REPLACEMENT PARTS

Model No. **MA790**, Spring Loaded 3" Swivel Caster

Model No. **VC055**, Rubber Foot Tip

20" WIDE ROLLING STEP LADDERS

- Frame is welded 1" round steel tubing
- Ideal wherever there is a need to reach materials
- Rolls easily into position and locks firmly to the floor for maximum safety
- Operate on spring-loaded casters
- Casters retract under operator's weight while rubber feet drop down
- Non-clogging slip-resistant steel steps
- Durable Kleton blue enamel finish
- Meets ANSI standard A14.7
- Step Size: 18" x 8"

300-LB. CAPACITY



Model No.	Number of Steps	Top Step Height"	Top Step W" x D"	Base Dim. W" x D"	Wt. lbs.
VC131	2	19	18 x 16	20 x 26	28
VC132	3	28	18 x 16	20 x 30	38
VC133	4	37	18 x 16	20 x 37	48
VC134	5	46	18 x 16	20 x 41	57

REPLACEMENT PARTS

Model No. **MA790**, Spring Loaded 3" Swivel Caster

Model No. **VC055**, Rubber Foot Tip

TRAILER ACCESS ROLLING LADDERS

- Provides secure, safe access to cube vans/trailers
- All welded steel construction, ships fully assembled and ready to use
- Front walk through with chain/snap assembly
- Non-clogging slip resistant steps
- 10" flat-free wheels in rear
- Drop down handles in front for easy maneuvering
- Durable Kleton Blue enamel finish
- Made in accordance with the ANSI A14.7 safety standard
- Step Size: 22" x 8"

300-LB. CAPACITY

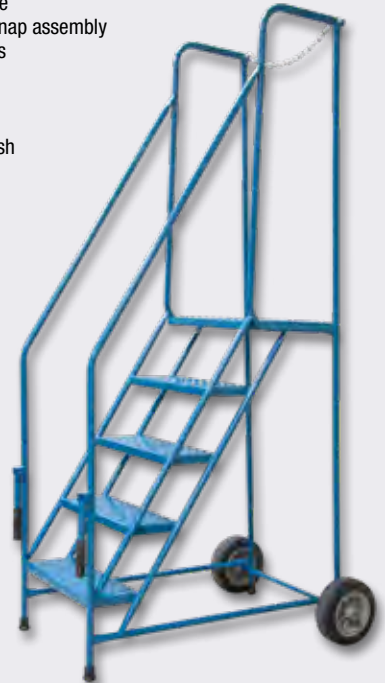

Model No.	Number of Steps	Top Step Height"	Top Step W" x D"	Base Dimensions W" x D"	Wt. lbs.
MO010	4	37	22 x 16	33 x 40	78
MO011	5	46	22 x 16	33 x 46	89
MO012	6	55	22 x 16	33 x 51	100

ROLLING LADDERS

Customize KLETON
products to your specs!
See Inside Front Cover



ROLLING LADDERS WITH SPRING LOADED FRONT CASTERS

- Frame is welded 1" round steel tubing
- Ideal wherever there is a need to reach materials
- Rolls easily into position and locks firmly to the floor for maximum safety
- 2 to 6-step ladders operate on spring-loaded casters
- Casters retract under operators weight while rubber feet drop down
- First step on all 8 to 16-step ladders activates the floor locking mechanism (step off and kick release to make the ladder mobile)
- Non-clogging slip-resistant steel steps
- Durable Kleton blue enamel finish
- CSA certified to the ANSI standard A14.7

300-LB.
CAPACITY



MA617

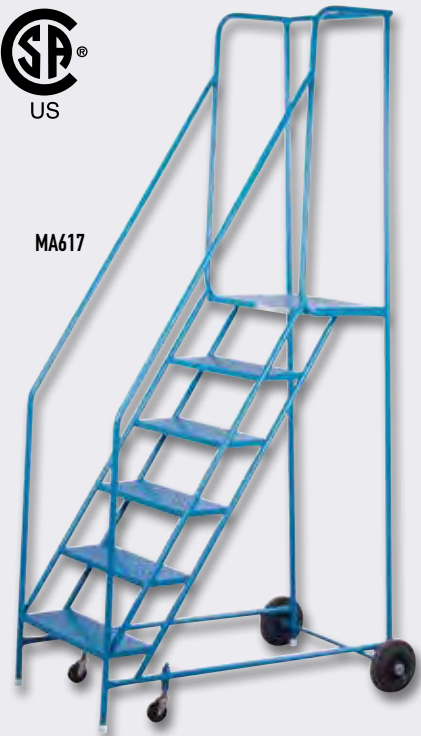

WITH SPRING-LOADED FRONT CASTERS

Model No.	Number of Steps	Step Size W" x D"	Top Step Height"	Top Step W" x D"	Overall Base Dimensions W" x D" x H"	Wt. lbs.
MA614	4	22 x 8	37	22 x 16	30 x 36 x 78	78
MA616	5	22 x 8	46	22 x 16	30 x 46 x 87	89
MA617	6	22 x 8	55	22 x 16	30 x 51 x 95	100

REPLACEMENT PARTS

- Model No. **MA790**, Spring Loaded 3" Swivel Caster
 Model No. **VC055**, Rubber Foot Tip
 Model No. **MH297**, Rubber 8" Wheel

ROLLING LADDERS WITH LOCKING STEP

- Frame is welded 1" round steel tubing
- Ideal wherever there is a need to reach materials
- Rolls easily into position and locks firmly to the floor for maximum safety
- 2 to 6-step ladders operate on spring-loaded casters
- Casters retract under operators weight while rubber feet drop down
- First step on all 8 to 16-step ladders activates the floor locking mechanism (step off and kick release to make the ladder mobile)
- Non-clogging slip-resistant steel steps
- Durable Kleton blue enamel finish
- CSA certified to the ANSI standard A14.7

300-LB.
CAPACITY



MA622



WITH SPRING-LOADED FRONT CASTERS

Model No.	Number of Steps	Step Size W" x D"	Top Step Height"	Top Step W" x D"	Overall Base Dimensions W" x D" x H"	Wt. lbs.
MA622*	8	30 x 8	72	30 x 16	38 x 60 x 113	180
MA623*	10	30 x 8	89	30 x 16	38 x 72 x 130	230
MA624*	12	30 x 8	109	30 x 16	38 x 80 x 149	250
MA625*	14	30 x 8	128	30 x 16	38 x 93 x 167	275
MA626*	16	30 x 8	144	30 x 16	38 x 104 x 185	305

* Shipped knocked down, easy assembly

REPLACEMENT PARTS

- Model No. **MC305**, 4" Swivel Rubber Caster for Ladders 8-Step and up
 Model No. **VC055**, Rubber Foot Tip
 Model No. **MH297**, Rubber 8" Wheel



Customize KLETON
products to your specs!
See Inside Front Cover

ROLLING LADDERS

TILT-N-ROLL LADDERS

- Frame is welded 1" round steel tubing
- Balanced design allows ladder to tilt into the rolling position
- 30" high rails with 24" wide non-clogging slip resistant steps
- Oversize 24" x 24" top step for easier worker movement
- Legs have rubber tips that hold ladder secure during use
- Ladder moves easily on two 4" casters
- Non-clogging slip-resistant steel steps
- Durable Kleton blue enamel finish
- Meets ANSI standard A14.7
- Step Size: 22" x 8"
- Top Step Size: 22" x 24"

**300-LB.
CAPACITY**

Optional
Tool Tray



Model No.	Number of Steps	Rise Height"	Top Step Height"	Height Top Rail"	Overall Dimensions W" x D" x H"	Wt. lbs.
MD603	3	9	27	30	25 x 44 x 57	70
MD604	4	9	38	30	25 x 50 x 68	81
MD605	5	9	47	30	25 x 56 x 77	93
MD606	6	9	56	30	25 x 62 x 86	105

REPLACEMENT PARTS

- Model No. **MH242**, Tool Tray (optional)
- Model No. **VC055**, Rubber Foot Tip
- Model No. **ML334**, 4" Rigid Rubber Caster

MECHANICS/MAINTENANCE ROLLING LADDERS

- Frame is welded 1" round steel tubing
- Double-straddle base puts worker in close proximity for hard-to-reach jobs
- Oversize 22" x 24" top step for easier worker movement
- Tilt and roll wheelbarrow style mobility allows easy movement over rough surfaces
- Removable 10" D x 24" W tool tray fits on front or side railing included
- Non-clogging slip-resistant steel steps
- Durable Kleton blue enamel finish
- Meets ANSI standard A14.7
- Step Size: 22" x 8"
- Top Step Size: 22" x 24"

Includes removable
10" D x 24" W tool tray.
Fits on front or
side railing.

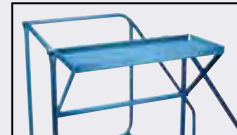

Model No.	Number of Steps	Rise Height"	Top Step Height"	Height Top Rail"	Overall Dimensions W" x D" x H"	Wt. lbs.
MH212	3	9	28	30	24 x 44 x 58	85
MH213	4	9	38	30	24 x 50 x 68	98
MH214	5	9	47	30	24 x 56 x 77	112
MH215	6	9	57	30	24 x 68 x 87	125

REPLACEMENT PARTS

- Model No. **MH242**, Tool Tray
- Model No. **VC055**, Rubber Foot Tip
- Model No. **ML334**, 4" Rigid Rubber Caster



PORTABLE FOLDING LADDERS

- Foldable locking design saves on storage space when not in use
- Welded construction
- Easy to maneuver
- 58° slope, 7" deep steps for easy climbing
- Non-clogging slip-resistant steel steps
- Locks in the folded or climbing positions

**350-LB.
CAPACITY**

Model No.	Number of Steps	Top Step Height"	Open W" x L"	Folded Dimensions W" x D" x H"	Wt. lbs.
VC436	2	20	24 x 17	24 x 10 x 41	30
VC437	3	30	24 x 23	24 x 10 x 52	35
VC438	4	40	24 x 30	24 x 10 x 65	42

REPLACEMENT PARTS

- Model No. **VC439**, 4" Polyurethane Wheel
- Model No. **VC440**, Rubber Foot Tip

MAINTENANCE PLATFORMS

CONVERTS FORKLIFT TRUCKS INTO A SAFE AND EFFICIENT WORK PLATFORM



MD444



Kleton High Work Maintenance Platform exceeds ASME B56.1 safety standard when a safety harness and lanyard are worn.

1 000-LB. CAPACITY

- All-welded design with a 14-gauge non-skid steel platform and 1-1/4" tubular steel frame
- Converts forklift trucks into a safe and efficient work platform
- Forks enter easily into channels and safety chains secure platform to fork carriage
- Welded safety gate is hinged to the platform
- 72" safety mesh back screen protects user from lift mechanism
- Durable Kleton blue enamel finish

Model No.	Side Rails Height"	Fork Channel Openings"	Channels (Centre to Centre)"	Overall Dimensions W" x D" x H"	Wt. lbs.
MD444	42	7 x 3	26	36 x 36 x 75	230
MH800	42	7 x 3	26	48 x 48 x 75	300

EMERGENCY STOP SWITCH

- Safety kill switch for person on work platform
- Will cut power to forklift in case of an emergency
- Consists of control box for platform, plug-in box (to be installed on forklift) and wire that extends 6' to 20'
- Switch is easy to install
- Recommended for maintenance platform model MD444 and MH800

Model No. MD328

MD328
Emergency Stop Switch



OPTIONAL TOOL TRAYS

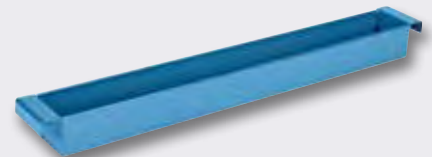

Model No.	Overall Dimensions W" x D" x H"	For Use with Model	Wt. lbs.
MI787	36 x 4 x 3	MD444	6
MI788	46 x 4 x 3	MH800	7

OPTIONAL LIGHT BULB CADDY

Model No.	Overall Dimensions W" x D" x H"	Wt. lbs.
MD948	15 x 15 x 43	25

MD948
Optional Light Bulb Caddy



OPTIONAL CASTER KIT



Model No.	Description	Wt. lbs.
MD338	Two rigid 6" phenolic & two swivel 6" phenolic casters	22

- Caster kit allows a person to move the platform around without the use of a forklift truck
- Compatible with both MD444 and MH800



WAREHOUSING & STORAGE

Lockers	96 - 97	Storage Bins & Racks	119 - 122
Locker Room Benches	96	Collapsible Containers	119
Wire Shelving	98 - 101	Bulk Stacking Containers	123
Chromate Wire Carts	102	Stacking Racks	124
Wire Shelving with Storage Bins	103	Reel Dispensers	124
Slanted & Basket Wire Shelving	104-105	Storage Racks	125 - 126
Wire Stock Picking Carts	105	Safety Guards	131
Wire Office Mail Carts	105	Racking Protectors	132
Collapsible Wire Container	105	Guard Rails	132
Green Epoxy Finish Wire Shelving	106 - 107	Gas Cylinder Cabinets	127
Wide Span Shelving	108	Wire Mesh Partitions	128 - 130
Heavy-Duty Boltless Shelving	108	Safety Guards	131
Parts Cabinets	109 - 113	Racking Protectors	132
Carousel Cabinet	109	Guard Rails	132 - 134
Storage Cabinets	114 - 115	Bollards, Protectors & Safety Guards	133
Hi-Stak Plastic Storage Bins	116	Strip Curtain Doors	135
Plastic Bins	117	Tarpaulins	136 - 138
Drawer Cabinets	118	Rubber Tie Downs	138

LOCKERS & LOCKER ROOM BENCHES

READY TO ASSEMBLE, THESE 16 GAUGE QUALITY LOCKERS WILL HELP KEEP BELONGINGS SAFE AND ORGANIZED.

READY TO ASSEMBLE STEEL LOCKERS

- Ships knocked down, ready to assemble with nuts and bolts included
- 16-gauge frames, 24-gauge body and shelves
- Double pan construction doors, 20-gauge outer and 24-gauge inner pans
- Stainless steel recessed padlock handles
- Magnetic latch ensures door is properly fastened when closed
- Three zinc-plated coat hooks and one shelf included with single and double tier lockers
- Durable powder-coated grey paint finish
- Number plates available separately
- Single tier dimensions: 12" W x 18" D x 72" H
- Double tier door height: 33-1/4"
- Lockerettes door height: 11"



SINGLE TIER

Dimensions:
12" W x 18" D x 72" H



DOUBLE TIER

Dimensions:
12" W x 18" D x 72" H
33-1/4" height per locker



LOCKERETTES

Dimensions:
12" W x 18" D x 72" H
11" height per lockerette



Three zinc-plated coat hooks and one shelf included with single and double tier lockers



Stainless steel recessed padlock handles. Magnetic latch ensures door is properly fastened when closed



Double pan construction doors, 20-gauge outer and 24-gauge inner pans 16-gauge frames, 24-gauge body and shelves

LOCKER ROOM BENCHES

- 16 gauge steel all-welded
- Wood top benches feature black powder coated legs that can be used free-standing or bolted to the floor
- Necessary for any locker room
- 9-1/4" wide rounded hardwood top



FB002



RL871

Model No.	Type	Dimensions L" x W" x H"	Wt. lbs.
FB002	Steel	72 x 12 x 17	35
RL871	Wood	48 x 9-1/2 x 16-1/2	23
RL872	Wood	60 x 9-1/2 x 16-1/2	29
RL873	Wood	72 x 9-1/2 x 16-1/2	31
RL874	Wood	96 x 9-1/2 x 16-1/2	39

READY TO ASSEMBLE, THESE 16 GAUGE
QUALITY LOCKERS WILL HELP KEEP
BELONGINGS SAFE AND ORGANIZED.

LOCKERS

SINGLE TIER



Model No.	Bank of	Wt. lbs.
FL362	1	52
FL363	2	96
FL364	3	139

W/SLOPE TOP

FL380	1	56
FL381	2	104
FL382	3	151

W/RECESSED BASE

FL392	1	56
FL393	2	104
FL394	3	151

W/SLOPE TOP & RECESSED BASE

FL404	1	60
FL405	2	112
FL406	3	163

DOUBLE TIER



Model No.	Bank of	Wt. lbs.
FL366	1	54
FL367	2	98
FL368	3	141

W/SLOPE TOP

FL384	1	57
FL385	2	106
FL386	3	153

W/RECESSED BASE

FL396	1	57
FL397	2	106
FL398	3	153

W/SLOPE TOP & RECESSED BASE

FL408	1	61
FL409	2	114
FL410	3	165

LOCKERETTES



Model No.	Bank of	Wt. lbs.
FL370	1	56
FL371	2	112
FL372	3	168

W/SLOPE TOP

FL388	1	60
FL389	2	120
FL390	3	180

W/RECESSED BASE

FL400	1	60
FL401	2	120
FL402	3	180

W/SLOPE TOP & RECESSED BASE

FL412	1	64
FL413	2	128
FL414	3	192



SLOPE TOP

- Helps eliminate dust build up
- Raises top by 10"



RECESSED BASE

- Prevents liquids from entering the locker
- Raises locker 4" off the ground

Model No.	Description
FL375	10" Slope Top
FL374	4" Recessed Base
FL376	Nuts & Bolts, Set of 1
FL518	Number Plates (Set of 1 to 25)
FL519	Number Plates (Set of 26 to 50)
FL520	Number Plates (Set of 51 to 75)
FL521	Number Plates (Set of 76 to 100)

STANDARD DUTY WIRE SHELVING

STANDARD DUTY WIRE MESH SHELVING

- Assembly required
- Adjustable feet compensate for surface irregularities
- Posts are double grooved every 8" and numbered for easy adjustment
- Capacity is based on evenly-distributed weight
- Shelf ribs run front to back allowing items to slide on and off shelves smoothly
- Post's circular grooves combined with tapered plastic split sleeves allow for assembly in minutes with no special tools
- Shelves with open wire design minimize dust, improve air circulation and provide greater visibility of stored items
- Shelves can be adjusted at precise 1" intervals
- Unit capacity should not exceed 1000 lbs.
- NSF Certified

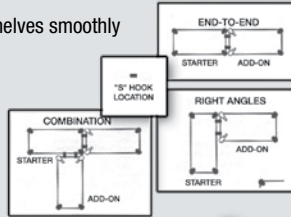

Model No.	Type	Dimensions D" x W" x H"	Cap Lbs. /Shelf*
RN529	Starter	14 x 36 x 63	500
RN530	Add-on	14 x 36 x 63	500
RN531	Starter	18 x 36 x 63	500
RN532	Add-on	18 x 36 x 63	500
RN533	Starter	18 x 48 x 63	500
RN534	Add-on	18 x 48 x 63	500
RN535	Starter	24 x 48 x 63	500
RN536	Add-on	24 x 48 x 63	500
RN537	Starter	24 x 72 x 63	400
RN538	Add-on	24 x 72 x 63	400
RN539	Starter	14 x 36 x 74	500
RN540	Add-on	14 x 36 x 74	500
RN541	Starter	18 x 36 x 74	500
RN542	Add-on	18 x 36 x 74	500
RN543	Starter	18 x 48 x 74	500
RN544	Add-on	18 x 48 x 74	500
RN545	Starter	24 x 48 x 74	500
RN546	Add-on	24 x 48 x 74	500
RN547	Starter	24 x 72 x 74	400
RN548	Add-on	24 x 72 x 74	400

* Evenly distributed weight

WIRE SHELVING COMPONENTS

- Shelf ribs run front to back allowing items to slide on and off shelves smoothly
- Shelves can be adjusted at precise 1" intervals
- Posts are double grooved every 8" and numbered for easy adjustment
- Adjustable feet compensate for surface irregularities
- Stationary unit's total capacity should not exceed 1000 lbs.
- Assembly required
- NSF certified

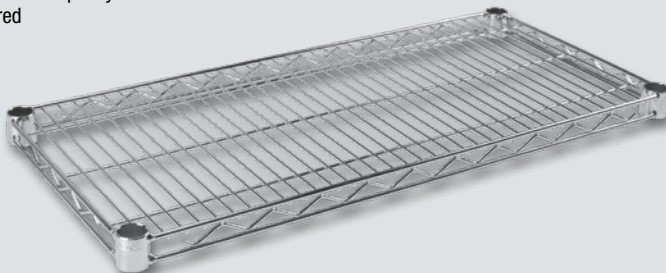

POSTS

Model No.	Height"	Wt. lbs.
RN522	33	4
RN523	54	6.3

WIRE SHELVES

Model No.	Dimensions D" x W"	Cap lbs.*	Wt. lbs.
RN524	14 x 36	500	7.5
RN525	18 x 36	500	8.25
RN526	18 x 48	500	10.5
RN527	24 x 48	500	14.25
RN528	24 x 72	400	17.5

* Evenly distributed weight

STANDARD DUTY WIRE SHELVING ACCESSORIES

WIRE BASKET SHELVES

- Shelves can be adjusted at precise 1" intervals
- Basket shelf design allows loose items to be contained and easily displayed
- NSF certified

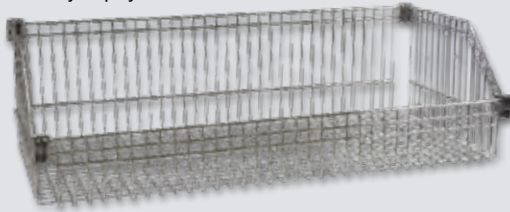

WIRE SLANTED SHELVES

- Shelves can be adjusted at precise 1" intervals
- Slanted shelf design allows for visibility and easy access to stored goods
- 3" front lip prevents items from sliding off the shelf
- NSF certified

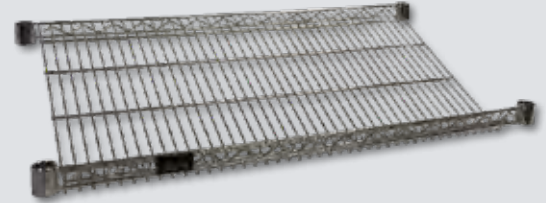

Model No.	Dimensions D" x W"	Cap lbs.*	Wt. lbs.
RN549	18 x 36	400	8
RN550	18 x 48	400	9
RN551	24 x 48	400	12.6

* Evenly distributed weight

Model No.	Dimensions D" x W"	Cap lbs.*	Wt. lbs.
RN552	18 x 36	400	7.72
RN553	18 x 48	400	9
RN554	24 x 48	400	12.6

* Evenly distributed weight

ACCESSORIES



RL048



RL049

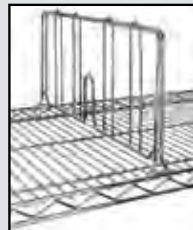

RL050
Divider



RL055
"S" Hook

Use S hooks to eliminate two posts per adjacent shelf. Two required per shelf.



RL054 - Split Sleeve



RL614 Ledge for Shelf

Model No.	Description	Wt. lbs.
RL048	Caster, 5", no brake	2.8
RL049	Caster, 5", with brake	2.7
RL050	Divider for shelf, 18"	1.7
RL051	Divider for shelf, 24"	2.2
RL052	Handle 18" - For utility carts	3.9
RL053	Handle 24" - For utility carts	4.4
RL054	Split Sleeves, black 4 Pc/bag	0.1
RL055	S-Hook for attaching Add-On	0.04
RL056	Leveling feet (Die cast and foot bolt)	0.2
RL057	Die cast for leveling feet	0.1
RL058	Foot bolt for leveling feet	0.1
RL614	Ledge for shelf, 14"	0.6
RL615	Ledge for shelf, 18"	0.75
RL616	Ledge for shelf, 24"	1
RL617	Ledge for shelf, 30"	2
RL618	Ledge for shelf, 36"	2.5
RL619	Ledge for shelf, 48"	3.5
RL620	Ledge for shelf, 60"	3.75
RL621	Ledge for shelf, 72"	4

RL056
Leveling
Foot



RN522
Post



HEAVY DUTY WIRE SHELVING ACCESSORIES

- Heavy-gauge chromate plated shelves with open wire design minimize dust, improve air circulation and provide greater visibility of stored items
- Post's circular grooves combined with tapered plastic split sleeves allow for assembly in minutes with no special tools

WIRE SHELVING COMPONENTS

- Shelf ribs run front to back allowing items to slide on and off shelves smoothly
- Shelves can be adjusted at precise 1" intervals
- Posts are double grooved every 8" and numbered for easy adjustment
- Adjustable feet compensate for surface irregularities
- Stationary unit's total capacity should not exceed 2000 lbs.
- Assembly required
- NSF Certified



WIRE SHELVES

Model No.	Dimensions D" x W"	Cap lbs.*	Wt. lbs.
RL606	14 x 30	800	7.5
RL607	14 x 36	800	8.25
RL608	14 x 48	800	10.5
RL609	14 x 60	600	12
RL610	14 x 72	600	15
RL035	18 x 30	800	6.9
RL036	18 x 36	800	8.5
RL037	18 x 48	800	10
RL038	18 x 60	600	14.5
RL039	18 x 72	600	15
RL040	24 x 36	800	10.5

WIRE SHELVES

RL041	24 x 48	800	14
RL042	24 x 60	600	17.8
RL043	24 x 72	600	22

* Evenly distributed weight

POSTS

Model No.	Height"	Wt. lbs.
RL611	33	4
RL330	54	6.3
RL331	63	7
RL332	74	8
RL333	86	8.8

ACCESSORIES



RL048

RL049



RL050
Divider



RL054 - Split Sleeve



RL055
"S" Hook

Use S hooks to eliminate two posts per adjacent shelf. Two required per shelf.



RL056
Leveling
Foot

RL330
Post

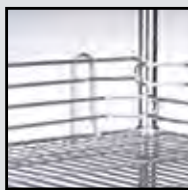

RL614 Ledge
for Shelf



RL612
Single Shelf Support



RL613
Double Shelf Support

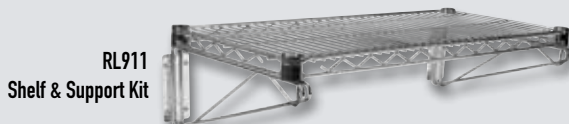

RL911
Shelf & Support Kit

Model No.	Description	Wt. lbs.
RL048	Caster, 5", no brake	2.8
RL049	Caster, 5", with brake	2.7
RL050	Divider for shelf, 18"	1.7
RL051	Divider for shelf, 24"	2.2
RL052	Handle 18" - For utility carts	3.9
RL053	Handle 24" - For utility carts	4.4
RL054	Split Sleeves, black 4 Pc/bag	0.1
RL055	S-Hook for attaching Add-On	0.1
RL056	Leveling feet (Die cast and foot bolt)	0.2
RL057	Die cast for leveling feet	0.1
RL058	Foot bolt for leveling feet	0.1
RL614	Ledge for shelf, 14"	0.6
RL615	Ledge for shelf, 18"	0.75
RL616	Ledge for shelf, 24"	1
RL617	Ledge for shelf, 30"	2
RL618	Ledge for shelf, 36"	2.5
RL619	Ledge for shelf, 48"	3.5
RL620	Ledge for shelf, 60"	3.75
RL621	Ledge for shelf, 72"	4

DIRECT WALL MOUNTS FOR WIRE SHELVING

Same great features as the Kleton chromate wire shelving, but with the added convenience of directly mounting on a wall.

- Wall mounts maximize available floor space
- Each wall mount unit consists of one shelf support and mounting plate
- Use single support at shelf ends; double support for adjoining shelves
- Installation note: Wall mounts must be securely fastened to materials of adequate load bearing strength. (Load rating: 200 lbs. (91kg) per system)

Model No.	Shelf Support	Shelf Depth"
RL612	Single	14
RL898	Single	18
RL900	Single	24
RL613	Double	14
RL899	Double	18
RL901	Double	24

WALL MOUNT WIRE SHELVING KITS

- Kit includes shelves, supports and mounting plate

Model No.	Description	Shelf Dimensions D" x W"
RL911	1 Shelf	14" x 30"
RL912	2 Shelves	14" x 30"

KLETON WIRE SHELVING CAN BE ASSEMBLED IN SEVERAL CONFIGURATIONS: END TO END, AT RIGHT ANGLES AS WELL AS MANY OTHER COMBINATIONS.

HEAVY DUTY WIRE SHELVING

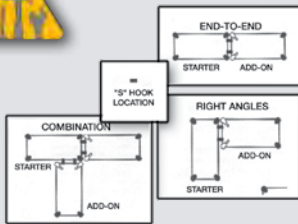

4 SHELVES

Model No.	Type	Dimensions D" x W" x H"	Cap Lbs. /Shelf*	Wt. Lbs.
63" POSTS				
RL907	Starter	14 x 30 x 63	800	39
RL908	Add-on	14 x 30 x 63	800	32
RL632	Starter	14 x 36 x 63	800	43
RL633	Add-on	14 x 36 x 63	800	35.5
RL634	Starter	14 x 48 x 63	800	49
RL635	Add-on	14 x 48 x 63	800	42
RL636	Starter	14 x 60 x 63	600	64.75
RL637	Add-on	14 x 60 x 63	600	57.75
RL638	Starter	14 x 72 x 63	600	71.5
RL639	Add-on	14 x 72 x 63	600	64
RL059	Starter	18 x 36 x 63	800	48
RL060	Add-on	18 x 36 x 63	800	41.6
RL061	Starter	18 x 48 x 63	800	58
RL062	Add-on	18 x 48 x 63	800	53.5
RL063	Starter	18 x 60 x 63	600	71
RL064	Add-on	18 x 60 x 63	600	65
RL065	Starter	18 x 72 x 63	600	75
RL066	Add-on	18 x 72 x 63	600	68
RL067	Starter	24 x 36 x 63	800	56
RL068	Add-on	24 x 36 x 63	800	49
RL069	Starter	24 x 48 x 63	800	70
RL070	Add-on	24 x 48 x 63	800	63
RL071	Starter	24 x 60 x 63	600	83
RL072	Add-on	24 x 60 x 63	600	77
RL073	Starter	24 x 72 x 63	600	101
RL074	Add-on	24 x 72 x 63	600	95

* Evenly distributed weight

5 SHELVES

Model No.	Type	Dimensions D" x W" x H"	Cap Lbs. /Shelf*	Wt. Lbs.
74" POSTS				
RL909	Starter	14 x 30 x 74	800	46.5
RL910	Add-On	14 x 30 x 74	800	39
RL640	Starter	14 x 36 x 74	800	51
RL641	Add-on	14 x 36 x 74	800	44
RL642	Starter	14 x 48 x 74	800	59
RL643	Add-on	14 x 48 x 74	800	42.8
RL644	Starter	14 x 60 x 74	600	78.75
RL645	Add-on	14 x 60 x 74	600	71
RL646	Starter	14 x 72 x 74	600	87
RL647	Add-on	14 x 72 x 74	600	79.5
RL075	Starter	18 x 36 x 74	800	58
RL076	Add-on	18 x 36 x 74	800	51
RL077	Starter	18 x 48 x 74	800	65
RL078	Add-on	18 x 48 x 74	800	58
RL079	Starter	18 x 60 x 74	600	88
RL080	Add-on	18 x 60 x 74	600	80
RL081	Starter	18 x 72 x 74	600	92
RL082	Add-on	18 x 72 x 74	600	85
RL083	Starter	24 x 36 x 74	800	68
RL084	Add-on	24 x 36 x 74	800	61
RL085	Starter	24 x 48 x 74	800	85
RL086	Add-on	24 x 48 x 74	800	78
RL087	Starter	24 x 60 x 74	600	103
RL088	Add-on	24 x 60 x 74	600	95
RL089	Starter	24 x 72 x 74	600	125
RL090	Add-on	24 x 72 x 74	600	118

86" POSTS

RL448	Starter	18 x 36 x 86	800	62
RL449	Add-on	18 x 36 x 86	800	53
RL450	Starter	18 x 48 x 86	800	69
RL451	Add-on	18 x 48 x 86	800	60
RL452	Starter	18 x 60 x 86	600	91.5
RL453	Add-on	18 x 60 x 86	600	82
RL454	Starter	18 x 72 x 86	600	96
RL455	Add-on	18 x 72 x 86	600	87
RL456	Starter	24 x 36 x 86	800	74
RL457	Add-on	24 x 36 x 86	800	65
RL458	Starter	24 x 48 x 86	800	90
RL459	Add-on	24 x 48 x 86	800	80
RL460	Starter	24 x 60 x 86	600	107
RL461	Add-on	24 x 60 x 86	600	97
RL462	Starter	24 x 72 x 86	600	129
RL463	Add-on	24 x 72 x 86	600	120

* Evenly distributed weight

CHROMATE WIRE CARTS

WIRE MESH UTILITY CARTS

- Durable, dependable transport solution
- Highly rigid construction that is easily adjustable at 1" increments
- Two handles allow for easy maneuverability
- Includes: 5" resilient rubber casters (two swivel, two with brake)
- One year limited warranty
- Shipped knocked down
- NSF Certified

800 - LB. CAPACITY
Evenly Distributed



Model No.	Dimensions D" x W" x H"	Wt. lbs.
-----------	-------------------------	----------

2 SHELVES

MK781	18 x 30 x 45	36.5
MK782	18 x 36 x 45	40.25
MK783	18 x 48 x 45	44.75
MK784	18 x 60 x 45	54
MK785	24 x 36 x 45	47.75
MK786	24 x 48 x 45	53.75
MK787	24 x 60 x 45	63.5

Model No.	Dimensions D" x W" x H"	Wt. lbs.
-----------	-------------------------	----------

3 SHELVES

MJ539	18 x 30 x 45	51.5
MJ540	18 x 36 x 45	56.5
MJ541	18 x 48 x 45	61
MJ542	18 x 60 x 45	74.25
MJ543	24 x 36 x 45	54
MJ544	24 x 48 x 45	63
MJ545	24 x 60 x 45	73.5

PUSH CARTS

- Durable, dependable transport solution
- Easy maneuverability
- Shelves can be adjusted quickly and easily
- Includes: 5" resilient rubber casters (two swivel, two with brake)
- One year limited warranty
- Shipped knocked down
- NSF Certified



600 - LB. CAPACITY
Evenly Distributed

Model No.	Dimensions D" x W" x H"	Wt. lbs.
-----------	-------------------------	----------

4 SHELVES

RL914	14 x 30 x 60	49
RL915	14 x 36 x 60	54.25
RL916	14 x 48 x 60	61.5
RL917	14 x 60 x 60	74.25

Model No.	Dimensions D" x W" x H"	Wt. lbs.
-----------	-------------------------	----------

5 SHELVES

RL918	14 x 30 x 60	55.5
RL919	14 x 36 x 60	61.75
RL920	14 x 48 x 60	70.75
RL921	14 x 60 x 60	86.5



WIRE SHELF CARTS

- Open-wire shelf design minimizes dust and increases air circulation and visibility
- High quality chromate plated shelves and posts prevent corrosion
- Shelves can be adjusted quickly and easily
- Strong and versatile
- Includes: 5" resilient rubber casters (two swivel, two with brake)
- One year limited warranty
- Shipped knocked down
- NSF Certified

800 - LB. CAPACITY
Evenly Distributed



Model No.	Dimensions D" x W" x H"	Wt. lbs.
-----------	-------------------------	----------

4 SHELVES

RL600	18 x 36 x 69	59.5
RL601	18 x 48 x 69	65
RL602	18 x 60 x 69	83
RL603	24 x 36 x 69	69
RL604	24 x 48 x 69	81
RL605	24 x 60 x 69	95
MJ527	18 x 36 x 80	60.75
MJ528	18 x 48 x 80	66.5
MJ529	18 x 60 x 80	85
MJ530	24 x 36 x 80	70.5
MJ531	24 x 48 x 80	82.5
MJ532	24 x 60 x 80	96.5

5 SHELVES

MJ533	18 x 36 x 92	73
MJ534	18 x 48 x 92	80
MJ535	18 x 60 x 92	102.5
MJ536	24 x 36 x 92	85
MJ537	24 x 48 x 92	96
MJ538	24 x 60 x 92	117.5

WIRE SHELVING WITH STORAGE BINS

WIRE SHELVING UNITS WITH STORAGE BINS

- Adjustable chromate wire shelves
- Wire shelving resists corrosion and provides greater visibility to stored parts
- Wire shelves prevent build up of dust and dirt
- Bins are unaffected by oil, alkaline, and most acids
- Ideal in production or for parts storage
- Total unit capacity should not exceed 2000 lbs.
- Assembly required



RL815



RL820



RL826



Model No.	Shelving Size D" x W" x H"	No. of Shelves	Bin Model No.*	No. of Bins	Colour
RL815	14 x 36 x 74	8	CB264	28	Blue
RL816	14 x 36 x 74	8	CB265	28	Yellow
RL817	14 x 36 x 74	8	CC236	28	Green
RL818	14 x 36 x 74	8	CC244	28	Red
RL819	18 x 36 x 74	8	CC239	28	Blue
RL820	18 x 36 x 74	8	CC240	28	Yellow
RL821	18 x 36 x 74	8	CC237	28	Green
RL822	18 x 36 x 74	8	CC245	28	Red
RL823	24 x 36 x 74	5	CF328	8	Blue
RL824	24 x 36 x 74	5	CF330	8	Yellow
RL825	24 x 36 x 74	5	CF329	8	Green
RL826	24 x 36 x 74	5	CF327	8	Red
RL827	18 x 48 x 74	8	CC239, CB266	28, 7	Blue
RL828	18 x 48 x 74	8	CC240, CB267	28, 7	Yellow
RL829	18 x 48 x 74	8	CC237, CC288	28, 7	Green
RL830	18 x 48 x 74	8	CC245, CC246	28, 7	Red
RL831	18 x 48 x 74	8	CC239, CB266	7, 21	Blue
RL832	18 x 48 x 74	8	CC240, CB267	7, 21	Yellow
RL833	18 x 48 x 74	8	CC237, CC238	7, 21	Green
RL834	18 x 48 x 74	8	CC245, CC246	7, 21	Red
RL835	24 x 48 x 74	5	CC239, CB266, CF328	4, 7, 6	Blue
RL836	24 x 48 x 74	5	CC240, CB267, CF330	4, 7, 6	Yellow
RL837	24 x 48 x 74	5	CC237, CC238, CF329	4, 7, 6	Green
RL838	24 x 48 x 74	5	CC245, CC246, CF327	4, 7, 6	Red
RL839	18 x 36 x 74	8	CB266, CC239	7, 14	Blue
RL840	18 x 36 x 74	8	CB267, CC240	7, 14	Yellow
RL841	18 x 36 x 74	8	CC238, CC237	7, 14	Green
RL842	18 x 36 x 74	8	CC246, CC245	7, 14	Red

* See Page 116 for bin dimensions

SLANTED & BASKET WIRE SHELVING

SLANTED WIRE SHELVING UNIT

- Slanted shelving allows for better visibility of stored items
- Includes 3 slanted shelves and 2 flat shelves
- Kit Type: Starter
- Shelf Capacity: 400 lbs.
- Overall Capacity: 1000 lbs.
- NSF Certified



Model No.	Dimensions D" x W" x H"	No. of Shelves
RN589	18 x 36 x 63	5
RN590	18 x 48 x 63	5
RN591	24 x 48 x 63	5
RN592	18 x 36 x 74	7
RN593	18 x 48 x 74	7
RN594	24 x 48 x 74	7

SLANTED SHELF CARTS

- Slanted shelving allows for better visibility of stored items
- Includes: (3) slanted shelves, (2) flat shelves, (2) swivel casters, (2) Rigid Casters
- Kit Type: Starter
- Shelf Capacity: 400 lbs.
- Overall Capacity: 1000 lbs.
- NSF Certified



Model No.	Dimensions D" x W" x H"	No. of Shelves
RN595	18 x 36 x 75	5
RN596	18 x 48 x 75	5
RN597	24 x 48 x 75	5
RN598	18 x 36 x 86	7
RN599	18 x 48 x 86	7
RN600	24 x 48 x 86	7

WIRE BASKET SHELVING UNIT

- Basket shelves help to keep items organized and visible, while preventing items from falling off the shelves
- Open wire provides optimal airflow and helps to reduce dust
- Kit Type: Starter
- Shelf Capacity: 400 lbs.
- Overall Capacity: 1000 lbs.
- NSF Certified



Model No.	Dimensions D" x W" x H"	No. of Shelves
RN609	24 x 36 x 74	5
RN610	18 x 48 x 74	5
RN611	24 x 48 x 74	5

WIRE BASKET SHELF CARTS

- Basket shelves help to keep items organized and visible, while preventing items from falling off the shelves
- Includes: (5) basket shelves, (2) swivel casters, (2) rigid casters
- Kit Type: Starter
- Shelf Capacity: 400 lbs.
- Overall Capacity: 1000 lbs.
- No. of Shelves: 5
- NSF Certified



Model No.	Dimensions D" x W" x H"	No. of Shelves
RN612	18 x 36 x 80	5
RN613	18 x 48 x 80	5
RN614	24 x 48 x 80	5

WIRE MESH CARTS

SLANTED WIRE SHELF CART WITH BINS

- Slanted shelving allows for better visibility of stored items
- Features 3 slanted shelves, 2 flat shelves
- Kit Type: Starter
- Shelf Capacity: 400 lbs.
- Overall Capacity: 1000 lbs.
- No. of Shelves: 5
- NSF Certified



WIRE MESH OFFICE MAIL CART

- Ideal for carrying hanging folders, packages and office supplies
- Comes with three wire dividers and two removable baskets
- Shipped knocked down
- Capacity: 250 lbs.
- Overall Depth: 23"
- Overall Length: 42"
- Overall Height: 38"
- Cart Material: Chrome Plated
- No. of Shelves: 2
- No. of Baskets: 2

Model No. **M0843**



Model No.	Overall Width"	Overall Height"	Overall Depth"	No. of Bins	Bin Colour
RN601	63	36	18	16	Blue
RN602	63	36	18	16	Yellow
RN603	63	36	18	16	Green
RN604	63	36	18	16	Red
RN605	63	48	18	20	Blue
RN606	63	48	18	20	Yellow
RN607	63	48	18	20	Green
RN608	63	48	18	20	Red

ENCLOSED WIRE STOCK PICKING CARTS

- High quality chromate shelves and posts prevent corrosion
- Enclosed sides keeps items from falling out
- Shelves can be adjusted quickly and easily
- Strong and versatile
- Includes: (2) 5" swivel resilient casters, (2) 5" rubber caster with brakes
- Shipped knocked down
- One-year limited warranty
- Capacity is based on evenly distributed weight
- No. of Shelves: 4
- Capacity: 800 lbs.
- Cart Material: Chrome Plated
- NSF Certified

Model No.	Overall Width"	Overall Height"	Overall Depth"
RN559	18	69	36
RN560	18	69	48
RN561	18	69	36
RN562	24	69	36
RN563	24	69	48
RN564	24	69	60

WIRE ENCLOSURE PANELS

Model No.	Dimensions W" x H"
RN556	15 x 61.5
RN557	18 x 61.5
RN558	21 x 61.5

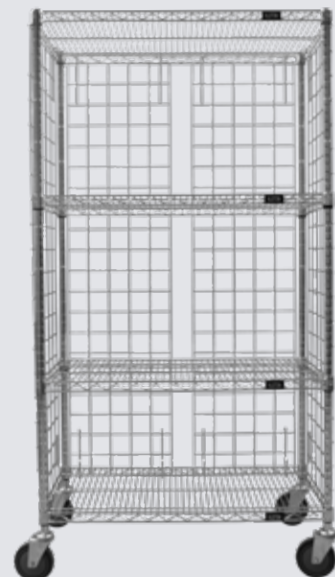

GREEN EPOXY FINISH WIRE SHELVING

- IDEAL FOR STORING SUPPLIES IN WAREHOUSES OR SHOPS
- BOLTLESS SHELVING SYSTEM CAN BE BUILT QUICKLY AND EASILY

GREEN EPOXY FINISH WIRE SHELVING COMPONENTS

- Ideal for use in wet environments
- Superior rust resistance
- Designed to minimize dust, improve air circulation, and provide greater visibility of stored items
- Post's circular grooves combined with tapered plastic sleeves allow for assembly in minutes with no special tools
- Shelf ribs run front to back allowing items to slide on and off shelves smoothly
- Shelves can be adjusted at precise 1" intervals
- Posts are double grooved every 8" and numbered for easy adjustment
- Adjustable feet compensate for surface irregularities
- Stationary unit's total capacity should not exceed 2000 lbs.
- Shipped knocked down
- NSF Certified



WIRE SHELVES

Model No.	D" x W"	Cap lbs. Shelf*
RN082	14 x 30	800
RN083	14 x 36	800
RN084	14 x 48	800
RN085	14 X 60	800
RN086	14 x 72	800
RN087	18 x 30	800
RL622	18 x 36	800
RL623	18 x 48	800
RL624	18 x 60	600
RL625	18 x 72	600
RL626	24 x 36	800
RL627	24 x 48	800
RL628	24 x 60	600
RN077	24 x 72	600

*Evenly distributed weight

POSTS

Model No.	Height"
RL629	63
RL630	74
RL631	86

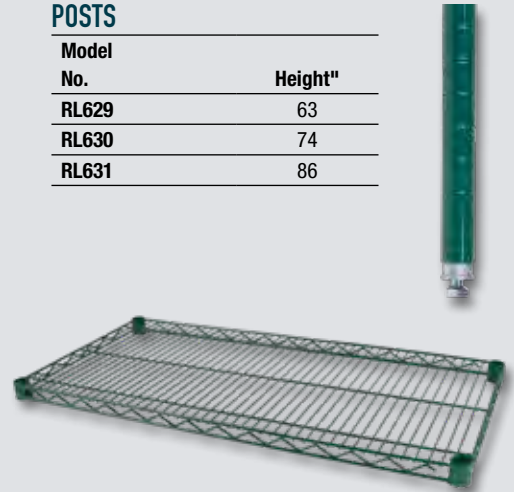

GREEN EPOXY FINISH WIRE SHELF CARTS

- Green epoxy wire shelf carts are ideal for use in wet environments
- Superior rust resistance
- Designed to minimize dust, improve air circulation, and provide greater visibility of stored items
- Shelves can be adjusted quickly and easily
- Strong and versatile
- Includes: 5" resilient rubber casters, two swivel, two with brake
- NSF certified
- One year limited warranty
- Shipped knocked down

600 - LB. CAPACITY
Evenly Distributed



4 SHELVES

Model No.	Dimensions D" x W" x H"	Wt. lbs.*
RN129	18 x 36 x 69	59
RN130	18 x 48 x 69	70
RN131	18 x 60 x 69	86
RN132	24 x 36 x 69	73
RN133	24 x 48 x 69	85
RN134	24 x 60 x 69	93
RL803	18 x 36 x 80	64
RL804	18 x 48 x 80	74
RL805	18 x 60 x 80	94
RL806	24 x 36 x 80	78
RL807	24 x 48 x 80	90
RL808	24 x 60 x 80	110

*Evenly distributed weight

5 SHELVES

Model No.	Dimensions D" x W" x H"	Wt. lbs.*
RL809	18 x 36 x 92	68
RL810	18 x 48 x 92	78
RL811	18 x 60 x 92	98
RL812	24 x 36 x 92	82
RL813	24 x 48 x 92	94
RL814	24 x 60 x 92	114

*Evenly distributed weight

- IDEAL FOR USE IN WET ENVIRONMENTS
- PERFECT FOR STORING SUPPLIES IN WAREHOUSES OR SHOPS
- NO BOLT SHELVING SYSTEM CAN BE BUILT QUICKLY AND EASILY

GREEN EPOXY FINISH WIRE SHELVING



RL648

GREEN EPOXY FINISH WIRE SHELVING

- Superior rust resistance
- Designed to minimize dust, improve air circulation, and provide greater visibility of stored items
- Post's circular grooves combined with tapered plastic sleeves allow for assembly in minutes with no special tools
- Shelf ribs run front to back allowing items to slide on and off shelves smoothly
- Shelves can be adjusted at precise 1" intervals
- Posts are double grooved every 8" and numbered for easy adjustment
- Adjustable feet compensate for surface irregularities
- Stationary unit's total capacity should not exceed 2000 lbs.
- Shipped knocked down
- NSF Certified

5 SHELVES

Model No.	Type	Dimensions D" x W" x H"	Cap lbs. Shelf
RN101	Starter	14 x 30 x 74	800
RN102	Add-on	14 x 30 x 74	800
RN103	Starter	14 x 36 x 74	800
RN104	Add-on	14 x 36 x 74	800
RN105	Starter	14 x 48 x 74	800
RN106	Add-on	14 x 48 x 74	800
RN107	Starter	14 x 60 x 74	600
RN108	Add-on	14 x 60 x 74	600
RN109	Starter	14 x 72 x 74	600
RN110	Add-on	14 x 72 x 74	600
RL662	Starter	18 x 36 x 74	800
RL663	Add-on	18 x 36 x 74	800
RN113	Starter	18 x 36 x 86	800
RN114	Add-on	18 x 36 x 86	800
RL664	Starter	18 x 48 x 74	800
RL665	Add-on	18 x 48 x 74	800
RN115	Starter	18 x 48 x 86	800
RN116	Add-on	18 x 48 x 86	800
RL666	Starter	18 x 60 x 74	600
RL667	Add-on	18 x 60 x 74	600
RN117	Starter	18 x 60 x 86	600
RN118	Add-on	18 x 60 x 86	600
RL668	Starter	18 x 72 x 74	600
RL669	Add-on	18 x 72 x 74	600
RN119	Starter	18 x 72 x 86	600
RN120	Add-on	18 x 72 x 86	600
RL670	Starter	24 x 36 x 74	800
RL671	Add-on	24 x 36 x 74	800
RN121	Starter	24 x 36 x 86	800
RN122	Add-on	24 x 36 x 86	800
RL672	Starter	24 x 48 x 74	800
RL673	Add-on	24 x 48 x 74	800
RN123	Starter	24 x 48 x 86	800
RN124	Add-on	24 x 48 x 86	800
RL674	Starter	24 x 60 x 74	600
RL675	Add-on	24 x 60 x 74	600
RN125	Starter	24 x 60 x 86	600
RN126	Add-on	24 x 60 x 86	600
RN111	Starter	24 x 72 x 74	600
RN112	Add-on	24 x 72 x 74	600
RN127	Starter	24 x 72 x 86	600
RN128	Add-on	24 x 72 x 86	600

*Evenly distributed weight

4 SHELVES

Model No.	Type	Dimensions D" x W" x H"	Cap lbs. Shelf
RN089	Starter	14 x 30 x 63	800
RN090	Add-on	14 x 30 x 63	800
RN091	Starter	14 x 36 x 63	800
RN092	Add-on	14 x 36 x 63	800
RN093	Starter	14 x 48 x 63	800
RN094	Add-on	14 x 48 x 63	800
RN095	Starter	14 x 60 x 63	600
RN096	Add-on	14 x 60 x 63	600
RN097	Starter	14 x 72 x 63	600
RN098	Add-on	14 x 72 x 63	600
RL648	Starter	18 x 36 x 63	800
RL649	Add-on	18 x 36 x 63	800
RL650	Starter	18 x 48 x 63	800
RL651	Add-on	18 x 48 x 63	800
RL652	Starter	18 x 60 x 63	600
RL653	Add-on	18 x 60 x 63	600
RL654	Starter	18 x 72 x 63	600
RL655	Add-on	18 x 72 x 63	600
RL656	Starter	24 x 36 x 63	800
RL657	Add-on	24 x 36 x 63	800
RL658	Starter	24 x 48 x 63	800
RL659	Add-on	24 x 48 x 63	800
RL660	Starter	24 x 60 x 63	600
RL661	Add-on	24 x 60 x 63	600
RN099	Starter	24 x 72 x 63	600
RN100	Add-on	24 x 72 x 63	600

*Evenly distributed weight

WIDE SPAN SHELVING

WIDE SPAN SHELVING WITH JUMBO PLASTIC BINS

- 12-gauge steel posts and 13-gauge beams
- Shelf levels include 5/8" particleboard decking and required tie bars
- Capacity is 800 lbs. per shelf (based on evenly distributed loads)
- Offered configurations include three levels with 12 bins and four levels with 16 bins.
- Plastic bin outside dimensions :15-1/2" W x 25" D x 13" H
- Assembly required



Model No.	Shelving Size D" x W" x H"	No. of Shelves	No. of Bins	Colour
RL984	18 x 66 x 60	3	12	Red
RL985	18 x 66 x 60	3	12	Blue
RL986	18 x 66 x 60	3	12	Green
RL987	18 x 66 x 60	3	12	Yellow
RL988	18 x 66 x 60	3	12	Red, Blue, Yellow
RL980	18 x 66 x 72	4	16	Red
RL981	18 x 66 x 72	4	16	Blue
RL982	18 x 66 x 72	4	16	Green
RL983	18 x 66 x 72	4	16	Yellow
RL989	18 x 66 x 72	4	16	Red, Blue, Yellow, Green



RL986



RL984



HEAVY-DUTY BOLTLESS SHELVING

- Modular design allows the unit to be set up as a shelving unit or as work bench
- Includes five Medium-Density Fiberboard (MDF) shelves
- Shelves snap into place quickly and easily
- Shelf capacity: 1200 lbs.
- 5 Shelves



Model No.	Shelving Unit Dimensions W" x D" x H"
RN455	36 x 18 x 72
RN456	36 x 24 x 72
RN457	48 x 18 x 72
RN458	48 x 24 x 72



CREATE YOUR OWN CARROUSEL
CABINET OR ORDER ONE OF OUR
3-TIER CABINET KITS

DRAWER CABINETS

HEAVY-DUTY INDUSTRIAL CARROUSEL DRAWER CABINETS CREATE YOUR CUSTOMIZED CARROUSEL CABINET

- Each level accommodates 4 parts cabinets with same height
- For a multiple tier cabinet (maximum 3 tiers), you require add-on-shelves and threaded rods as per the following: 1 add-on-shelf **CF402** for each level of cabinets, 14" rod required for each level of **CF312** or **CF305** cabinets 25" rod required for each level of **CC453** or **CF314** cabinets
- Rotating base allows for 800-lb. capacity
- All-welded 11-gauge steel base
- Durable Kleton grey enamel finish

Model No.	Description	Dimensions W" x D" x H"	Wt. lbs.
CF401	Rotating Base and Top Cover	27-1/2 x 27-1/2 x 4	80
CF402	Add-on Shelf	27-1/2 x 27-1/2 x 1	18
CF403	Threaded Rod - 14"	3/8 x 14	1
CF404	Threaded Rod - 25"	3/8 x 25	1-1/2
CF305	Parts Cabinet - 16 Drawers	18-5/16 x 8-11/16 x 14	21
CF312	Parts Cabinet - 20 Drawers	18-5/16 x 8-11/16 x 14	21
CC453	Parts Cabinet - 32 Drawers	18-5/16 x 8-11/16 x 25	31
CF314	Parts Cabinet - 40 Drawers	18-5/16 x 8-11/16 x 25	40



CF408
Includes:
Qty: 12 - CF314 - Cabinet - 40 drawers
Qty: 1 - CF401 - Rotating Base and Top Cover
Qty: 2 - CF404 - Threaded Rod 25"
Qty: 2 - CF042 - Add-on Shelf

3 TIER CABINET KITS

CF405 - 192 DRAWERS

- Includes:**
12 - **CF305** Parts Cabinets
1 - **CF401** Rotating Base and Top Cover
2 - **CF402** Add-on Shelf
3 - **CF403** Threaded Rods 14"



CF406 - 240 DRAWERS

- Includes:**
12 - **CF312** Parts Cabinets
1 - **CF401** Rotating Base and Top Cover
2 - **CF402** Add-on Shelf
3 - **CF403** Threaded Rods 14"



CF407 - 384 DRAWERS

- Includes:**
12 - **CC453** Parts Cabinets
1 - **CF401** Rotating Base and Top Cover
2 - **CF402** Add-on Shelf
3 - **CF404** Threaded Rods 25"



CF408 - 480 DRAWERS

- Includes:**
12 - **CF314** Parts Cabinets
1 - **CF401** Rotating Base and Top Cover
2 - **CF402** Add-on Shelf
3 - **CF404** Threaded Rods 25"



Model No.	Description	Dimensions W" x D" x H"	Wt. lbs.
CF405	192 Drawers	27 x 27 x 48	392
CF406	240 Drawers	27 x 27 x 48	407
CF407	384 Drawers	27 x 27 x 80	497
CF408	480 Drawers	27 x 27 x 80	600

CF408



PARTS CABINETS

KPC-HD HEAVY-DUTY PARTS CABINETS

- Reinforced heavy-duty steel shelves provide extra durability
- Drawer size: 6-1/2" W x 14-13/16" D x 4-1/8" H
- New design allows 98% use of drawer space to store larger tools or materials
- Housed in all-welded galvanized steel cabinet
- Label with clear plastic cover and divider included with every drawer
- Grey enamel finish
- Heavy-duty ABS black drawers

CF323



Model No.	No. of Drawers	Cabinet Size W" x D" x H"	Wt. lbs.
CF323	30	34-5/8 x 15-11/16 x 34-5/8	119

REPLACEMENT PARTS

Model No. **CF324**, Drawer

Model No. **CF546**, Black Divider

Model No. **CF343**, Label Cover

Model No. **CF344**, Label

KPC-100 PARTS CABINETS

- Drawer size: 6-3/8" W x 11-5/16" D x 2-11/16" H
- New design allows 98% use of drawer space to store larger tools or materials
- Housed in all-welded galvanized steel cabinet
- Label with clear plastic cover and divider included with every drawer
- Plastic tabs and drawer stoppers allow for full extension without risk of spilling
- Grey enamel finish
- Heavy-duty ABS beige drawers

CF285



Model No.	No. of Drawers	Cabinet Size W" x D" x H"	Wt. lbs.
CF283	12	23 x 11-3/8 x 13-13/16	28
CF285	36	23 x 11-3/8 x 36-7/8	60

REPLACEMENT PARTS

Model No. **CF286**, Drawer

Model No. **CF287**, Clear Divider

Model No. **CF545**, Black Divider

Model No. **CF341**, Label Cover

Model No. **CC310**, Label

CF283



PARTS CABINETS



CA889

KPC-200 PARTS CABINETS

- Drawer size: 5-7/8" W x 9-13/16" D x 3-5/16" H
- New design allows 98% use of drawer space to store larger tools or materials
- Housed in all-welded galvanized steel cabinet
- Label with clear plastic cover and divider included with every drawer
- Plastic tabs and drawer stoppers allow for full extension without risk of spilling
- Grey enamel finish
- Heavy-duty ABS beige drawers

Model No.	No. of Drawers	Cabinet Size W" x D" x H"	Wt. lbs.
CA889	30	21-1/8 x 10-1/2 x 36-3/4	58

REPLACEMENT PARTS

Model No. **CF481**, Drawer
 Model No. **CF548**, Black Divider
 Model No. **CF341**, Label Cover
 Model No. **CC310**, Label



CA890



KPC-300 PARTS CABINETS

- Drawer size: 5-7/8" W x 9-13/16" D x 1-5/8" H
- New design allows 98% use of drawer space to store larger tools or materials
- Housed in all-welded galvanized steel cabinet
- Label with clear plastic cover and divider included with every drawer
- Plastic tabs and drawer stoppers allow for full extension without risk of spilling
- Grey enamel finish
- Clear polystyrene drawers

Model No.	No. of drawers	Cabinet Size W" x D" x H"	Wt. lbs.
CA890	60	21-5/16 x 10-3/8 x 36-7/8	60

REPLACEMENT PARTS

Model No. **CB984**, Drawer
 Model No. **CF194**, Clear Divider
 Model No. **CF549**, Black Divider
 Model No. **CF024**, Label Cover
 Model No. **CF340**, Label

PARTS CABINETS

KPC-400 PARTS CABINETS

- Drawer size: 4-11/16" W x 8-5/8" D x 2-11/16" H
- New design allows 98% use of drawer space to store larger tools or materials
- Housed in all-welded galvanized steel cabinet
- Label with clear plastic cover and divider included with every drawer
- Plastic tabs and drawer stoppers allow for full extension without risk of spilling
- Grey enamel finish
- Heavy-duty ABS beige drawers

Model No.	No. of Drawers	Cabinet Size W" x D" x H"	Wt. lbs.
CF298	16	23-1/8 x 8-11/16 x 13-13/16	24
CA891	24	17-5/16 x 8-11/16 x 25-5/8	33
CA892	48	22-5/8 x 8-11/16 x 36-7/8	58
CD440*	48	22-5/8 x 10-4/5 x 36-7/8	66.8

* Comes with locking doors

REPLACEMENT PARTS

Model No. **CF025**, Lock with two

Numbered Keys for **CD440**

Model No. **CB985**, Drawer

Model No. **CC309**, Clear Divider

Model No. **CF550**, Black Divider

Model No. **CF341**, Label Cover

Model No. **CC310**, Label



KPC-500 PARTS CABINETS

- Drawer size: 3-1/2" W x 8-5/8" D x 2-11/16" H
- New design allows 98% use of drawer space to store larger tools or materials
- Housed in all-welded galvanized steel cabinet
- Label with clear plastic cover and divider included with every drawer
- Plastic tabs and drawer stoppers allow for full extension without risk of spilling
- Grey enamel finish
- Clear polystyrene drawers

Model No.	No. of Drawers	Cabinet Size W" x D" x H"	Wt. lbs.
CF304	15	13-7/8 x 8-11/16 x 16-5/16	22
CF305	16	18-5/16 x 8-11/16 x 13-13/16	21
CC453	32	18-1/8 x 8-11/16 x 25-5/8	31
CC454	60	22-5/8 x 8-11/16 x 36-7/8	68

REPLACEMENT PARTS

Model No. **CC455**, Drawer

Model No. **CF551**, Black Divider

Model No. **CF341**, Label Cover

Model No. **CC310**, Label

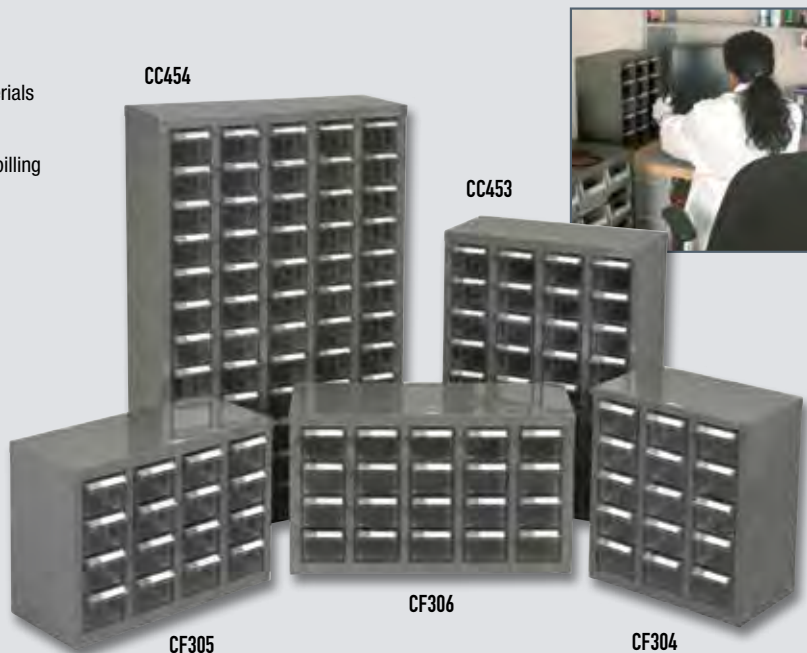

PARTS CABINETS



KPC-600 PARTS CABINETS

- Drawer size: 3-1/2" W x 8-5/8" D x 2-3/16" H
- New design allows 98% use of drawer space to store larger tools or materials
- Housed in all-welded galvanized steel cabinet
- Label with clear plastic cover and divider included with every drawer
- Plastic tabs and drawer stoppers allow for full extension without risk of spilling
- Grey enamel finish
- Clear polystyrene drawers

Model No.	No. of Drawers	Cabinet Size W" x D" x H"	Wt. lbs.
CF311	18	13-7/8 x 8-11/16 x 16-5/16	19
CF312	20	18-5/16 x 8-11/16 x 13-13/16	21
CF313	25	23-1/8 x 8-11/16 x 13-13/16	27
CF314	40	18-5/16 x 8-11/16 x 25-5/16	40
CF315	75	23-1/8 x 8-11/16 x 36-7/8	66



REPLACEMENT PARTS

- Model No. **CF316**, Drawer
- Model No. **CF552**, Black Divider
- Model No. **CF341**, Label Cover
- Model No. **CC310**, Label

KPC-700 PARTS CABINETS

- Drawer size: 4-11/16" W x 8-5/8" D x 2-3/16" H
- New design allows 98% use of drawer space to store larger tools or materials
- Housed in all-welded galvanized steel cabinet
- Label with clear plastic cover and divider included with every drawer
- Plastic tabs and drawer stoppers allow for full extension without risk of spilling
- Grey enamel finish
- Clear polystyrene drawers

Model No.	No. of Drawers	Cabinet Size W" x D" x H"	Wt. lbs.
CF318	20	23-1/8 x 8-11/16 x 13-5/8	25
CF320	60	23-1/8 x 8-11/16 x 36-7/8	71

REPLACEMENT PARTS

- Model No. **CF321**, Drawer
- Model No. **CF553**, Black Divider
- Model No. **CF341**, Label Cover
- Model No. **CC310**, Label



STORAGE CABINETS

DEEP DOOR STORAGE CABINETS

- All-welded heavy-duty 16-gauge deep door steel cabinet
- Four reinforced 16-gauge adjustable cabinet shelves with 500-lb capacity per shelf
- 4" deep doors for maximum storage capacity
- 12 adjustable door shelves with 35-lb capacity per shelf
- Unique padlock hasp helps prevent access with bolt cutters
- Powder coat Kleton grey finish
- Padlock sold separately (See below)

Model No.	Description	Dimension W" x D" x H"	Wt. lbs.
FB024	Cabinet	38 x 24 x 72	315
FB025	Extra Shelf for Cabinet	38 x 17 x 1	18
FB026	Extra Shelf for Door	18 x 6 x 1/2	2



ACCESSORIES

Model No.	Description
SA898	Padlock Keyed Different
SR892	Padlock Keyed Alike



FB024

84-BIN - DEEP DOOR COMBINATION CABINETS

- All-welded heavy-duty 16-gauge deep door, combination bin/shelf cabinet
- Four reinforced 16-gauge main adjustable shelves with 500-lb capacity per shelf
- Incorporates louvered bin hanging panels welded into the cabinets 4" deep hinged doors
- Unique padlock hasp helps prevent access with bolt cutters
- Powder coat Kleton grey finish
- Padlock sold separately (See above)

CABINET ONLY

Model No.	Description	Dimension W" x D" x H"	Wt. lbs.
CB442	Cabinet Only	38 x 24 x 72	324
FB025	Extra Shelf for Cabinet	38 x 17 x 1	18

CABINETS WITH BINS

Model No.	Bin Colour	Wt. lbs.	Each Cabinet Comes Complete with the Following Bins: 84 - 4-1/8" x 5-3/8" x 3" (10 lb. Capacity)
CB446	Blue	341	
CB477	Red	341	
CB448	Yellow	341	
CB693	Green	341	



CB448

STORAGE CABINETS

98-BIN DEEP DOOR COMBINATION CABINETS



- All-welded heavy-duty 16-gauge deep door, combination bin/shelf cabinet
- Two reinforced 16-gauge main adjustable shelves with 500-lb capacity per shelf
- Incorporates louvered bin hanging panels welded to the cabinet's back and doors
- Unique padlock hasp helps prevent access with bolt cutters
- Powder coat Kleton grey finish
- Padlock sold separately (See page 114)

CABINET ONLY

Model No.	Description	Dimensions W" x D" x H"	Wt. lbs.
FH820	Cabinet Only	38 x 24 x 72	316
FB025	Extra Shelf	38 x 17 x 1	18

Model No.	Bin Colour	Wt. lbs.	Each Cabinet Comes Complete with the Following Bins:
CF355	Blue	385	48 - 4-1/8" x 5-3/8" x 3" (10-lb. Capacity)
CF356	Red	385	36 - 4-1/8" x 7-3/8" x 3" (10-lb. Capacity)
CF354	Yellow	385	8 - 8-1/4" x 14-3/4" x 7" (60-lb. Capacity)
CF357	Green	385	6 - 16-1/2" x 14-3/4" x 7" (75-lb. Capacity)

118-BIN DEEP DOOR COMBINATION CABINETS



- All-welded heavy-duty 16-gauge deep door steel cabinet with 118 bins
- Incorporates louvered bin hanging panels welded to the cabinet's back and on its 4" deep hinged doors for added storage
- Unique padlock hasp helps prevent access with bolt cutters
- Powder coat Kleton grey finish
- Padlock sold separately (See Page 114)

CABINET ONLY

Model No.	Description	Dimensions W" x D" x H"	Wt. lbs.
CB441	Cabinet Only	38 x 24 x 72	316

CABINETS WITH BINS

Model No.	Bin Colour	Wt. lbs.	Each Cabinet Comes Complete with the Following Bins:
CB443	Blue	385	42 - 4-1/8" x 5-3/8" x 3" (10-lb. Capacity)
CB444	Red	385	42 - 4-1/8" x 7-3/8" x 3" (10-lb. Capacity)
CB445	Yellow	385	18 - 5-1/2" x 10-7/8" x 5" (30-lb. Capacity)
CB691	Green	385	12 - 8-1/4" x 14-3/4" x 7" (60-lb. Capacity)
			4 - 16-1/2" x 14-3/4" x 7" (75-lb. Capacity)

HI-STAK PLASTIC STORAGE BINS

- Innovative stacking design allows for greater visibility and easier access to contents
- Distortion-free from -40°C to 120°C
- Unaffected by oil, alkaline, and most acids
- Ideal in production or for parts storage

BIN DIMENSIONS: 4-13/16" W X 7-1/8" D X 3-3/16" H



Model No.	Colour
CB260	Blue
CB261	Yellow
CC234	Green
CC242	Red
CC441	Replacement Faceplate & Label
CC263	Replacement Legs

BIN DIMENSIONS: 5-7/8" W X 9-13/16" D X 4-11/16" H



Model No.	Colour
CB262	Blue
CB263	Yellow
CC235	Green
CC243	Red
CC441	Replacement Faceplate & Label
CC263	Replacement Legs

BIN DIMENSIONS: 8-3/16" W X 14" D X 6-3/16" H



Model No.	Colour
CB264	Blue
CB265	Yellow
CC236	Green
CC244	Red
CC443	Replacement Faceplate & Label
CC437	Replacement Legs

BIN DIMENSIONS: 7-7/8" W X 17-11/16" D X 7" H



Model No.	Colour
CC239	Blue
CC240	Yellow
CC237	Green
CC245	Red
CC443	Replacement Faceplate & Label
CC437	Replacement Legs

BIN DIMENSIONS: 11-13/16" W X 17-11/16" D X 7" H



Model No.	Colour
CB266	Blue
CB267	Yellow
CC238	Green
CC246	Red
CC443	Replacement Faceplate & Label
CC437	Replacement Legs

INCLUDED FEATURES



Connector clip allows for back-to-back mounting



1" riser legs increase loading capacity and stability



Inclined faceplate with removable label and protector
CC441: 3" x 1/2"
CC443: 5-13/16" x 11"

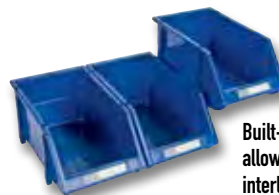

Built-in extrusions allow side-by-side interlock



Stackable using built-in feet

ALL BINS ARE AVAILABLE IN 4 COLOURS



PLASTIC BINS

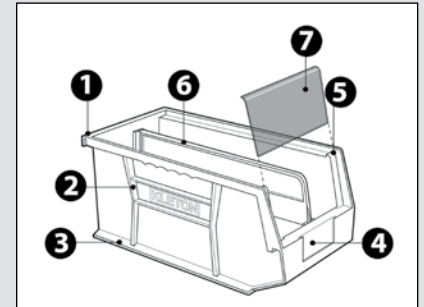
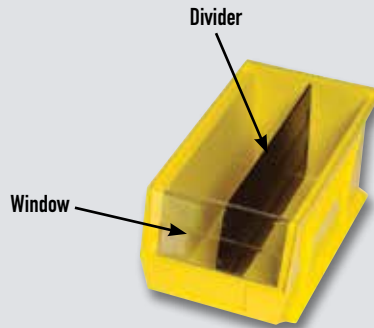
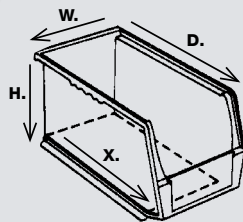

1. Full width hanger supports bins when suspended from louvered panels or rails
2. Reinforced rib design adds strength and prevents spreading when stacked
3. Extra-wide ledges for secure stacking and stability
4. Large front label slots ideal for larger bar code scanning and content identification
5. Anti-slide stop prevents stacked bins from shifting forward
6. Optional dividers increase storage options
7. Optional windows maximize storage capacity, prevent spillage and protect parts from dust and dirt

Bin Model No.					Outside Dimensions W" x D" x H"	Inside Dimensions W" x D" x H"	Inside Bottom Depth X"	Bin Load Cap. lbs.	Uses Divider	Uses Clear Window
Blue	Red	Yellow	Green	Black						
CF820	CF822	CF823	CF821	CF824	4-1/8 x 5-3/8 x 3	3-7/16 x 4-3/4 x 2-13/16	4	10	CB825	-
CF825	CF827	CF828	CF826	CF829	4-1/8 x 7-3/8 x 3	3-7/16 x 6-3/4 x 2-13/16	6	10	CB826	-
CF830	CF832	CF833	CF831	CF834	5-1/2 x 10-7/8 x 5	4-3/8 x 10-1/4 x 4-3/4	9	30	CB829	CB814
CF835	CF837	CF838	CF836	CF839	11 x 10-7/8 x 5	10 x 10-1/4 x 4-3/4	9	50	CB829	CB815
CF840	CF842	CF843	CF841	CF844	8-1/4 x 10-3/4 x 7	6-9/16 x 10 x 6-3/4	8	50	CB830	CB818
CF845	CF847	CF848	CF846	CF849	8-1/4 x 14-3/4 x 7	6-9/16 x 14 x 6-3/4	12	60	CB831	CB818
CF850	CF852	CF853	CF851	CF854	16-1/2 x 14-3/4 x 7	14-3/4 x 14 x 6-3/4	12	75	CB831	CB819

JUMBO PLASTIC CONTAINERS

- Extra-large size provides massive amount of storage capacity
- Guaranteed unbreakable and distortion-free from -40°C to 120°C
- Unaffected by oil, alkaline, and most acids
- Nesting design allows for minimal storage space when not in use
- Stackable for added space savings, up to four high
- Outside Dimensions: 15-1/2" W x 25" D x 13" H
- Inside Dimensions: 13-1/2" W x 22-3/5" D x 12" H
- Capacity: 200 lbs.

Model No.	Colour
CF328	Blue
CF330	Yellow
CF329	Green
CF327	Red



DRAWER CABINETS

HEAVY-DUTY TILT BINS

- Extremely durable ABS plastic housing and drawer body
- Transparent polystyrene front window for easy viewing
- Conveniently connects to each other with grooved channels on top, bottom and sides
- Shake resistant design prevents drawers from opening on their own
- Keyholes on back for wall mounting applications
- Colour: Black and grey



Model No.	No. of Drawers	Bin Dimensions W" x D" x H"	Cabinet Dimensions W" x D" x H"	Wt. lbs.
CF471	8	2-3/4 x 3-1/4 x 3-5/8	11-3/4 x 2-3/4 x 7-7/8	1.8
CF472	6	3-11/16 x 4 x 4-5/8	11-3/4 x 3-1/2 x 9-3/4	2.26
CF473	5	4-1/2 x 4-7/8 x 5-1/2	23-1/2 x 4 x 5-7/8	2.84
CF474	4	5-5/8 x 6-3/8 x 7-1/2	23-1/2 x 5-1/2 x 7-7/8	3.10

MOBILE TILT BIN RACKS

- Heavy-duty steel frame
- Durable powder coat paint finish on galvanised steel
- 3" swivel casters with brake
- Single or double sided use
- Overall dimensions: 26-1/4" W x 22" D x 57-1/2" H
- Colour: Grey

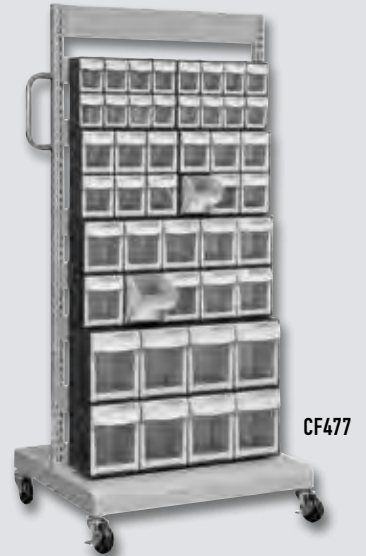

Model No.	Description	Bin Units Included
CF477	Single Sided	2 of each CF471, CF472, CF473, CF474
CF478	Double Sided	4 of each CF471, CF472, CF473, CF474
CF475*	Cart Only	-
CF476	Mounting Channel for Heavy-Duty Tilt Bins	
CF502	Mounting Channel for Plastic Bins	

* Mounting channels and bins not included

MOUNTING CHANNEL CF476 FOR MOBILE TILT BIN RACK

- Takes up to six mounting channels per side
- CF473 tilt bins take up to eight mounting channels per side
- CF471 and CF472 take 2 bin units per level per side



SEE PLASTIC BINS FOR CF502 MOUNTING CHANNEL on Page 117



MA246



DRAWER CABINET TRUCKS

- Allows repair or assembly parts to be transported directly to the work site
- Lower shelf provides added storage capacity
- Rolls smoothly on two rigid and two swivel 5" rubber casters
- Drawers come with two adjustable dividers and full width handles
- Overall truck dimensions: 36" W x 18" D x 35" H

Model No.	No. of Drawers	Bin Dimensions W" x D" x H"	Wt. lbs.
MA245	18	5-3/8 x 17 x 3-1/2	134
MA246	24	5-3/8 x 17 x 2	145
MA247	36	5-3/8 x 17 x 3-1/2	195
MA248	48	5-3/8 x 17 x 2	220

COLLAPSIBLE CONTAINERS

COLLAPSIBLE CONTAINERS

- Polypropylene construction
- Reinforced base for added durability
- 16 heavy-duty steel pins built in for increased strength
- Collapses to 21" L x 14" W x 2" H for convenient storage
- Open dimensions: 21" L x 14" W x 10-1/2" H
- Capacity: 160 lbs.

Model No. **CF326**



CF326



COLLAPSED

COLLAPSIBLE BULK CONTAINER

- Drop gates knock-down with ease
- Quickly collapsed, folded, and stacked for convenient transportation
- Max. Height: 39.4"
- Max. Length: 47.2"
- Max. Width: 39.4"
- No. of Drop Gates: 2
- Capacity: 2000 lbs.
- Colour: Grey

Model No. **CF862**

Lid for Collapsible Bulk Container

Model No. **CF863**



CF863
Lids Sold Separately

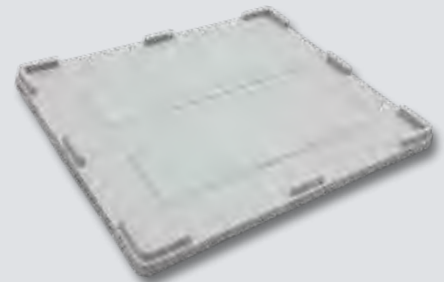

COLLAPSED

STORAGE BINS & RACKS

Customize KLETON
products to your specs!
See Inside Front Cover



HANGING METAL BIN PANELS

- Wall mount, attached to the back of shelving, mount on benches, carts, inside cabinets, fasten to slotted angle components, or use for service truck interior
- Bins are easily removed, refilled and replaced
- Each heavy-duty panel is 16-gauge cold-rolled steel
- Slotted holes 3/4" L x 3/8" W at 6" centres simplify installation
- Kleton grey powder coated
- Installation note: Panels must be securely fastened to materials of adequate load bearing strength
- Each panel must be secured vertically at the centre

CF412
(Bins not included)

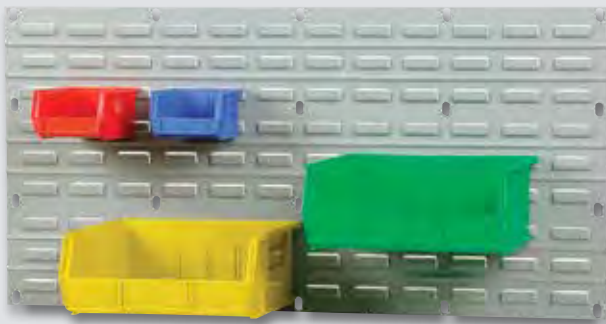

METAL BIN PANELS

Model No.	Panel Size W" x H"	Wt. lbs.
CF411	18 x 19	6
CF412	36 x 19	12

BIN QUANTITY TABLE - QUANTITY OF IDENTICAL PLASTIC BINS THAT FIT MODEL CF412 PANEL

Outside Bin Dimensions W" x D" x H"	Qty of Bins 1 Panel	Qty of Bins 2 Panel	Qty of Bins 3 Panel	Qty of Bins 4 Panel
4-1/8 x 5-3/8 x 3	32	72	104	144
4-1/8 x 7-3/8 x 3	32	72	104	144
5-1/2 x 10-7/8 x 5	18	36	54	72
11 x 10-7/8 x 5	9	18	27	36
8-1/4 x 10-3/4 x 7	8	18	28	36
8-1/4 x 14-3/4 x 7	8	16	28	36
16-1/2 x 14-3/4 x 7	4	8	14	18

NOTE: IF MOUNTING MORE THAN 1 PANEL

2 Panels = 37" H, 3 Panels = 55" H, 4 Panels = 73" H
Width of 2 panels combined: 35-3/4"

36" LOUVERED BENCH RACKS

- All-welded louvered bench rack
- Free standing unit made of 1" square tube frame
- May be placed on any flat surface near a worksite without the need for bolts or fasteners
- Durable Kleton blue enamel finish

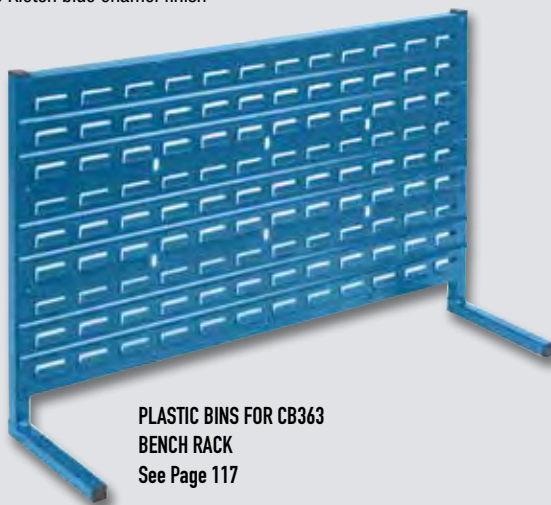

PLASTIC BINS FOR CB363
BENCH RACK
See Page 117

Model No.	Description	Dimensions W" x D" x H"	Wt. lbs.
CB363	Free Standing Bench Rack Only	36 x 10 x 22	22

RACK WITH BIN COMBINATIONS



W/Red Bins	W/Blue Bins	W/Yellow Bins	W/Green Bins	Outside Bin Dimensions W" x D" x H"	Bin Qty	Bin Cap lbs.
CB146	CB145	CB147	CF359	4-1/8 x 5-3/8 x 3	32	320
CB152	CB151	CB153	CF361	4-1/8 x 7-3/8 x 3	32	320
CB155	CB154	CB156	CF363	5-1/2 x 10-7/8 x 5	18	540



Customize KLETON products to your specs!
See Inside Front Cover

STORAGE BINS & RACKS

72" LOUVERED BENCH RACKS

- Provides tool and parts storage for assembly or repair operations when combined with plastic parts bins
- All-welded louvered bench rack
- Designed to be permanently installed on a 72" wide workbench
- Constructed of 1-1/4" square tube frame
- Durable Kleton blue enamel finish

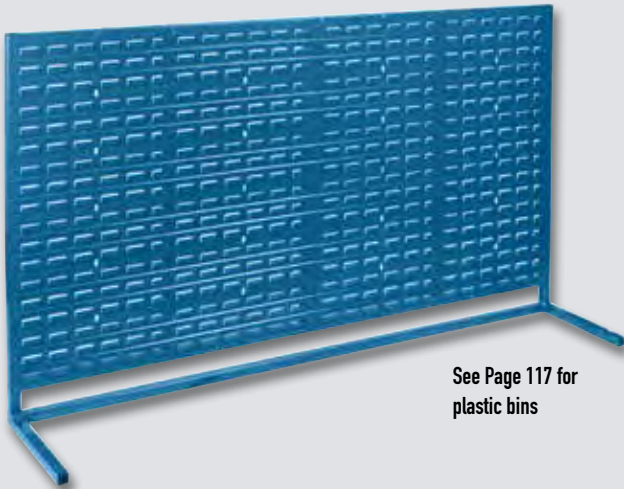

See Page 117 for plastic bins

Model No.	Description	Dimensions W" x D" x H"	Wt. lbs.
CB364	Bolt-on Bench Rack	72 x 15 x 40	95

RACK WITH BIN COMBINATIONS



W/Red Bins	W/Blue Bins	W/Yellow Bins	W/Green Bins	Outside Bin Dimensions W" x D" x H"	Bin Qty	Total Bin Cap lbs.
CB173	CB172	CB174	CF365	4-1/8 x 7-3/8 x 3	144	1440
CB176	CB175	CB177	CF367	5-1/2 x 10-7/8 x 5	72	2160
CB185	CB184	CB186	CF369	8-1/4 x 14-3/8 x 7	36	2160



STATIONARY RACKS WITH BIN COMBINATIONS

- Designed to be permanently installed to the floor
- All-welded stationary bin racks
- Constructed of 1 1/4" square tube frame
- Choose from either single or double-sided racks to meet your storage needs
- Durable Kleton blue enamel finish

W/Red Bins	W/Blue Bins	W/Yellow Bins	W/Green Bins	Rack Type	Outside Bin Dimensions W" x D" x H"	Bin Qty	Total Bin Capacity lbs.
CB654	CB655	CB656	CB685	Single-Sided	8-1/4 x 14-3/4 x 7	28	1680
CB370	CB371	CB372	CB687	Double-Sided	8-1/4 x 14-3/4 x 7	56	3360

ACCESSORIES FOR LOUVERED PANELS

Model No.	Description
CC165	Round Hook, 6"
CC166	Round Hook, 12"
CC167	Square Hook, 6"
CC168	Square Hook, 12"



Round Hook



Square Hook

STORAGE BINS & RACKS

MOBILE BIN CARTS

- All-welded bin cart
- Work surface made of 14-gauge steel
- Includes bolted-on 5" non-marking casters and two louvered panels
- Durable Kleton blue enamel finish



**1000-LB.
CAPACITY**

Model No.	Description	Dimensions W" x D" x H"	Wt. lbs.
CB365	Cart Only	24 x 38-1/2 x 36-1/2	95

BIN QUANTITY TABLE QUANTITY OF IDENTICAL PLASTIC BINS THAT FIT MODEL CB365

Outside Bin Dimensions				Qty of Bins
W"	x	D"	x H"	
8-1/4	x	14-3/4	x 7	16
16-1/2	x	14-3/4	x 7	4



CARTS/BIN COMBINATION

W/Blue Bins	W/Red Bins	W/Yellow Bins	W/Green Bins	Bin /Qty
CB366	CB367	CB368	CB689	20

MOBILE SINGLE SIDED BIN RACKS

- Ideal for transportation of small parts
- All-welded single-sided mobile bin rack
- Includes 3" casters and two louvered panels
- Durable Kleton blue enamel finish



**800-LB.
CAPACITY**

Model No.	Description	Dimensions W" x D" x H"	Wt. lbs.
CB359	Rack Only	36 x 16 x 52	60

BIN QUANTITY TABLE QUANTITY OF IDENTICAL PLASTIC BINS THAT FIT MODEL CB359

Outside Bin Dimensions				Qty of Bins
W"	x	D"	x H"	
5-1/2	x	10-7/8	x 5	36



**800-LB.
CAPACITY**

RACK WITH BIN COMBINATIONS

W/Blue Bins	W/ Red Bins	W/Yellow Bins	W/Green Bins	Bin /Qty
CB650	CB651	CB652	CB681	36

MOBILE DOUBLE SIDED BIN RACKS

- Ideal for transportation of small parts
- All-welded double-sided mobile bin rack
- Includes bolted-on 5" non-marking casters and six louvered panels
- Durable Kleton blue enamel finish



**1000-LB.
CAPACITY**

Model No.	Description	Dimensions W" x D" x H"	Wt. lbs.
CB649	Rack Only	36 x 24 x 63	120

**1000-LB.
CAPACITY**

RACK WITH BIN COMBINATIONS.

W/Blue Bins	W/Red Bins	W/Yellow Bins	W/Green Bins	Bin /Qty
CB089	CB090	CB091	CB683	96





Customize KLETON
products to your specs!
See Inside Front Cover

BULK STACKING CONTAINERS

MESH CONTAINERS

- Heavy-duty all-welded construction
- Mesh containers use 2" x 2" x 10-gauge wire mesh
- All containers use a 13-gauge corrugated sheet steel base
- 2" x 2" x 3/16" angle posts
- 4-way fork truck entry with 4" under-clearance
- Available with one drop gate or fully enclosed sides
- Height: 24" inside, 30" overall
- Stackable up to 5 high
- Other sizes are available
- Painted durable Kleton blue

**3000-LB.
CAPACITY**

CF449



CF450



Model No.	Description	Capacity lbs.	Width"	Length"	Wt. lbs.
CF449	Fully Enclosed	3000	34-1/2	40-1/2	125
CF450	One Drop Gate	3000	34-1/2	40-1/2	130
CF451	Fully Enclosed	3000	40-1/2	48-1/2	150
CF452	One Drop Gate	3000	40-1/2	48-1/2	160

**4500-LB.
CAPACITY**



**3500-LB.
CAPACITY**



SHEET CONTAINERS

Model No.	Description	Capacity lbs.	Width"	Length"	Wt. lbs.
CF453	Fully Enclosed	3500	34-1/2	40-1/2	150
CF454	One Drop Gate	3500	34-1/2	40-1/2	150
CF455	Fully Enclosed	3500	40-1/2	48-1/2	185
CF456	One Drop Gate	3500	40-1/2	48-1/2	185

CORRUGATED CONTAINERS

Model No.	Description	Capacity lbs.	Width"	Length"	Wt. lbs.
CF457	Fully Enclosed	4500	34-1/2	40-1/2	160
CF458	One Drop Gate	4500	34-1/2	40-1/2	160
CF459	Fully Enclosed	4500	40-1/2	48-1/2	195
CF460	One Drop Gate	4500	40-1/2	48-1/2	195

STACKING RACKS & REEL DISPENSERS

Customize KLETON products to your specs!
See Inside Front Cover

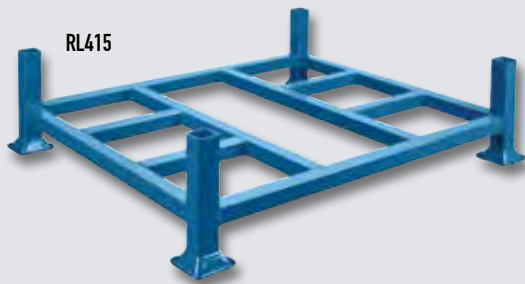

RL415

STACKING RACKS

4000-LB. CAPACITY

- Utilize warehouse airspace and lower the chances of damage that is associated with bulk stacking
- Designed for storage of loose and palletized goods
- Rugged all-welded 2" sq. tubing steel construction
- Holds 4000 lbs per rack and can be stacked four high
- Posts and bases are sold separately
- All-welded steel construction, ready to use
- Customizable to your specs
- Durable Kleton blue enamel finish

OPEN BASE FRAME

Model No.	Inside Dimensions D" x W"	Overall Dimensions D" x W"	Wt. lbs.
RL414	38 x 44	42 x 48	85
RL415	44 x 44	48 x 48	90

CLOSED BASE FRAME

RL416	38 x 44	42 x 48	110
RL417	44 x 44	48 x 48	115

ACCESSORIES

Model No.	Description	Overall Dimensions W" x H"	Wt. lbs.
RL418	42" Side Rail	42 x 48	30
RL419	48" Side Rail	48 x 48	32
RL420	42" Upright Post-Pack of 4	2 x 42	35
RL421	48" Upright Post-Pack of 4	2 x 48	40
RL422	60" Upright Post-Pack of 4	2 x 60	50

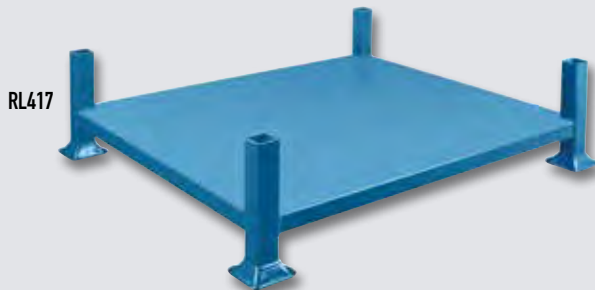

RL417



RL414 with 2 RL419

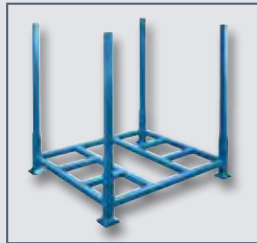

RL414 with 4 RL421



3000-LB. CAPACITY

CABLE REEL ROLLERS

- For winding or dispensing cable, chain, wire, rope and hose
- Turns reel handling into a one-person operation
- Accommodates unlimited reel widths and all reel diameters with flanges up to 5-1/2" thick
- Heavy-duty side rollers eliminate slipping or wedging between rollers and reel
- Inclined ramp permits for easy loading and unloading
- Durable Kleton blue enamel finish

Model No.	Overall Dimensions L" x W" x H"	Inclined Ramp Angle	Pair Wt. lbs.
MD166	28 x 9 x 4-1/4	68°	58

REPLACEMENT WHEEL

Model No.	Description
MC064	3" Polyolefin Wheel

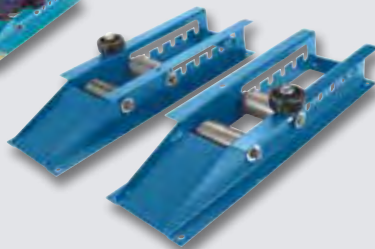



Customize KLETON
products to your specs!
See Inside Front Cover

STORAGE RACKS

HORIZONTAL BAR STORAGE RACKS

- Ideal for storing bars, tube, pipe and angle
- Horizontally stores bars up to 10' long
- 9" deep arms with nine storage levels at 6" intervals
- Capacity: 1200 lbs.
- Durable Kleton blue enamel finish
- All-welded steel construction
- Shipped knocked down

**1200-LB.
CAPACITY**

Model No.	Overall Dimensions W" x D" x H"	Wt. lbs.
RB958	18 x 40 x 84	68

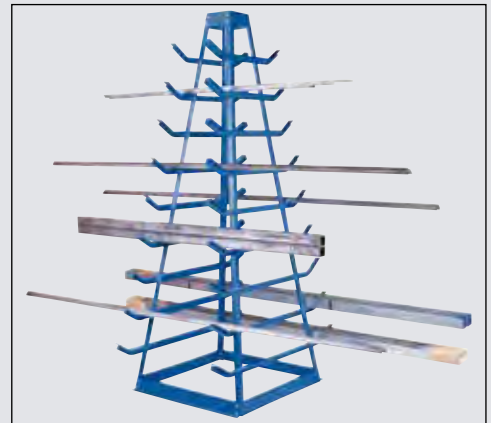

VERTICAL BAR STORAGE RACKS

- Ideal for storing bars, tube, pipe and angle
- All-welded steel construction
- Vertically stores bars up to 10' long
- Four 24" deep dividers
- Capacity: 3000 lbs.
- Durable Kleton blue enamel finish

**3000-LB.
CAPACITY**



COMBINATION VERTICAL RACKS

- Stores bars up to 12' long and features three shelves for extra storage of small parts
- 8" deep arms divided into three sections
- Durable KLETON blue enamel finish
- Shipped knocked down

**3000-LB.
CAPACITY**



Model No.	Overall Dimensions W" x D" x H"	Wt. lbs.
RL383	48 x 24 x 60	100

Model No.	Overall Dimensions W" x D" x H"	Wt. lbs.
RL922	36 x 24 x 84	128

STORAGE RACKS

Customize KLETON
products to your specs!
See Inside Front Cover



STANDARD VERTICAL SHEET RACKS

**4000-LB.
CAPACITY**

- All-welded steel construction
- Designed for vertically storing sheet goods
- 4 bays with 10" between each bay
- Constructed of heavy gauge steel 1-1/4" tube for bays and a heavy gauge steel 1" x 2" rectangular tube for the frame
- Each bay can hold up to 1000 lbs.
- Capacity: 4000 lbs.
- Durable Kleton blue enamel finish

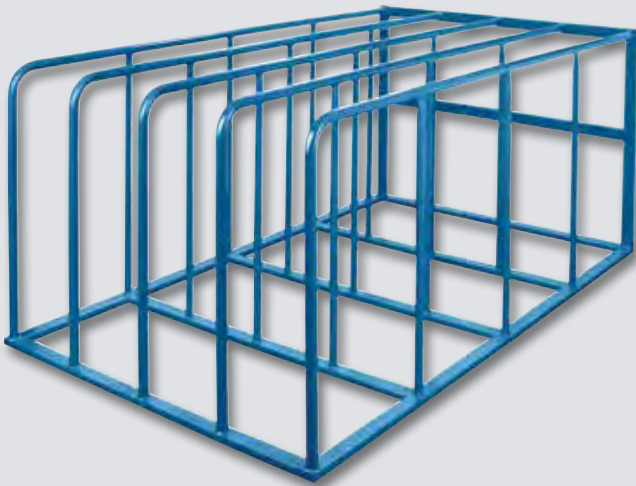

Model No.	Overall Dimensions L" x W" x H"	Wt. lbs.
RL384	50 x 84 x 36-3/4	200

HORIZONTAL SHEET RACKS

**2000 - LB.
CAPACITY**
Evenly Distributed

- Designed for storage of sheet materials
- Flat storage fully supports materials and reduces warping
- Sheets are accessible from all four sides
- All-welded construction and the frame is made of 2" square tubing
- Five shelf design creates four storage bays spaced 9-1/2" apart and an open top bay
- Bay Capacity: 2000 lbs. evenly distributed
- Maximum rack capacity: 8000 lbs.



Model No.	Overall Dimensions L" x W" x H"	Wt. lbs.
RL923	103 x 55 x 48	575

**600-LB.
CAPACITY**

CARTON RACKS

- All-welded steel construction, ready to use
- Single tier rack has 20" high dividers with 10-1/2" space between the dividers
- Double tier rack has 20" high dividers on the bottom with 10-1/2" space between the dividers and 14" high dividers on the top with 8-1/2" space between the dividers
- Capacity: 600 lbs.
- Durable KLETON blue enamel finish

Model No.	Overall Dimensions W" x D" x H"
-----------	------------------------------------

SINGLE TIER RACK

MN423	48 x 18 x 22
-------	--------------

DOUBLE TIER RACK

MN424	48 x 18 x 58-1/2
-------	------------------

Convert rack to a mobile
unit using option
caster set MN425





Customize KLETON
products to your specs!
See Inside Front Cover

GAS CYLINDER CABINETS

GAS CYLINDER CABINETS

- Heavy-duty construction
- Innovative door design allows for left or right opening installation
- 2" x 2" 10-gauge formed steel angle posts
- 9-gauge wire mesh doors and walls for venting
- 14-gauge checker plate shelves and roof
- English and French warning labels included
- Padlock hasp for added security
- Safety yellow powder coat finish
- Shipped knocked down (except **SEB837** and **SEB838**)

COMPRESSED GAS (9" GAS CYLINDER BOTTLES)

Model No.	Dimensions W" x D" x H"	Cylinder Capacity	Wt. lbs.
SAF837	44 x 30 x 74	10	210
SAF848*	88 x 30 x 74	20	420

* Consists of two units of **SAF837**

Model No.	Dimensions W" x D" x H"	Cylinder Capacity	Wt. lbs.
SEB837*	30 x 17 x 37	2	70
SEB838*	17 x 17 x 69	2	85
SEB836	44 x 30 x 37	6	135
SEB847	44 x 30 x 74	12	270

Notes: Constructed to meet or exceed strict CSA international B149.2-00 Propane Storage and Handling Code. Cylinders must be stored vertically at all times.
*Fully assembled all-welded construction



SAF837



SAF848



SEB837



SEB838



SAF836



SAF847

WIRE MESH PARTITIONS & ENCLOSURES

- 2" x 2" x 10-gauge wire mesh
- 10-gauge frame (stiffeners included on all applicable sizes)
- Pre-drilled modular components allow for quick and easy installation
- Durable KLETON blue or safety yellow finish (Other colours available)



WIRE MESH PARTITION COMPONENTS

Everything necessary to create your own custom enclosure.
Fast and easy assembly, multiple sizes available.
Please follow these guidelines for determining the components required.

1. UNIVERSAL POSTS

A post must be placed at each end of every panel (or of every stack of panels). Be sure to calculate an extra 2" of overall wall length for each post added. When a post meets an existing wall, add one **KD115** wall bracket for proper support (fasteners are included with **KD115** to mount to post, not to wall).

UNIVERSAL POSTS

Blue Model No.	Yellow Model No.	Height	Wt. lbs.
KD053	KH860	8' 3"	22
KD046	KH922	10' 3"	27
KD050	KH923	12' 3"	32



2. PANELS

Whenever possible, stacking panels horizontally (one above the other) is more economical than placing them vertically (next to each other) - this is because fewer posts are required for wall support when panels are stacked.

Examples:

- For an 8' high partition, stack two **KD037** (8' x 4') panels horizontally
- For a 10' high partition, stack two **KD037** (8' x 4') and one **KD033** (8' x 2') panel horizontally
- For a 12' high partition, stack three **KD037** (8' x 4') panels horizontally

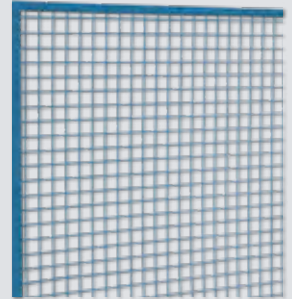

PANELS

Blue Model No.	Yellow Model No.	Black Model No.	Frame Dim. W' x H'	Wt. lbs
KD121	KH926	RN615	4 x 1	10
KD120	KH927	RN616	8 x 1	21
KD030	KH928	RN617	2 x 2	10
KD031	KH929	RN618	3 x 2	11
KD032	KH914	KI278	4 x 2	12
KD033	KH915	KI279	8 x 2	31
KD034	KH916	KI280	8 x 3	40
KD035	KH930	RN619	3 x 4	20
KD036	KD130	KI281	4 x 4	23
KD037	KD131	KI282	8 x 4	45

3. ADJUSTABLE FILLER PANELS

Adjustable filler panels fill in blank spots on the ends of wire mesh partitions to plug up potential security risks. Filler panels come in two sizes: 1' x 4' and 1' x 8' that slide over the ends of existing wire mesh sections. Bolt holes on the filler panels are separated per every inch and allow the filler panel to fill in a space between 6" and 10" wide. The holes line up with holes on the existing panel which are drilled in at the top and bottom to securely fasten the filler panel in two places.

Adjustable Filler Panels



Blue Model No.	Yellow Model No.	Black Model No.	Dimensions W' x H'	Wt. lbs.
KD119	KH924	RN620	4 x 1	5
KD118	KH925	RN621	8 x 1	10



Safety Yellow



Customize KLETON products to your specs!
See Inside Front Cover

- Heavy-duty construction
- Innovative door design allows for left or right opening installation

WIRE MESH PARTITIONS & ENCLOSURES

WIRE MESH PARTITION COMPONENTS CONT'D

4. SWING DOORS

Heavy-Duty

- Frame constructed with 1-1/4" x 1-1/4" square tube and 1" x 1" angle iron
- All are 7' in height and include a 1' transom for a total of 8' height
- May swing outwards to the left or to the right (except the **KD112** and **KH937** heavy swing door with wicket which swings open to the left only)
- Fasteners are included

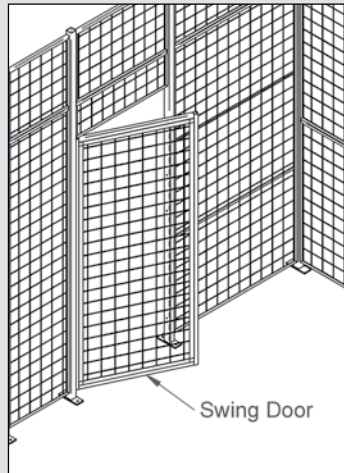

Standard-Duty

- Frame constructed with 1-1/4" x 1-1/4" angle iron frame
- All are 7' in height and include a 1' transom for a total of 8' height
- May swing outwards to the left or to the right
- Fasteners are included

5. SLIDING DOORS

Heavy-Duty

- Frame constructed with 1-1/4" x 1-1/4" square tube and 1" x 1" angle iron
- All are 7' 7" in height and require one or more 8' lengths of 5" tall sliding door track, for a total of 8' height
- All sliding doors may slide open to the left or to the right
- To properly mount a sliding door, a post must be located on the side onto which the door slides, at the same distance away from the opening as the doors width

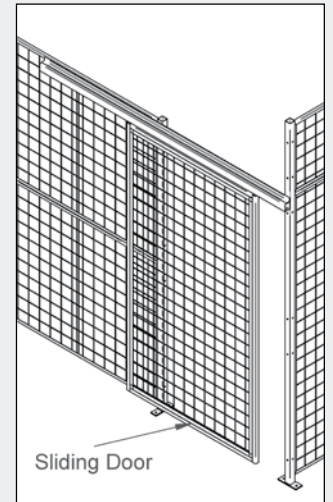

Standard-Duty

- Frame constructed with 1-1/2" x 1-1/2" angle iron frame
- All are 7' 7" in height and require one or more 8' lengths of 5" tall sliding door track, for a total of 8' height
- All sliding doors may slide open to the left or to the right
- To properly mount a sliding door, a post must be located on the side onto which the door slides, at the same distance away from the opening as the doors width

Blue Model No.	Yellow Model No.	Black Model No.	Description	Dim. W' x H'
KD110	KH933	RN628	Heavy-Duty Door	3 x 7
KH853	KH934	RN626	Standard-Duty Door	3 x 7
KD111	KH935	RN629	Heavy-Duty Door	4 x 7
KH854	KH936	RN627	Standard-Duty Door	4 x 7
KD112	KH937	RN630	Door c/w Wicket	4 x 7

Blue Model No.	Yellow Model No.	Black Model No.	Description	Dim. W' x H'
KH852	KH938	RN625	Standard-Duty Door	4 x 8
KD106	KH939	RN622	Heavy-Duty Door	4 x 8
KD108	KH940	RN624	Heavy-Duty Door	8 x 8
KD107	KH941	RN623	Heavy-Duty Door	8 x 10

6. HARDWARE REQUIRED

For Each Stacked Panel Add:

- 4 x **MMH254**, 4 x **MMB721** for each 8' stacked panel
- 2 x **MMH254**, 2 x **MMB721** for each stacked panel under 8' long

For Each Post Add:

- 8 x **MMH262**, 8 x **MMB721**, 2 x **KD001** for each **KD053** and **KH860**
- 12 x **MMH262**, 12 x **MMB721**, 2 x **KD001** for each **KD046** and **KH922**
- 12 x **MMH262**, 12 x **MMB721**, 2 x **KD001** for each **KD050** and **KH923**

For Each Sliding Door Add:

- 1 x **KD028**, 1 x **KD029** door track for each **KD106** and **KH852** 4' wide sliding door
- 1 x **KD028**, 2 x **KD029** door track for each **KD108** and **KD107** 8' wide sliding door

Blue Model No.	Yellow Model No.	Description	Wt. lbs.
KD029	KH942	8' Door Track	16
KD028	KH943	Sliding Door Hardware Kit	6
KD115	KH944	Wall Bracket Kit	0.1
MMH254*	-	5/16" x 1" Carriage Bolt	0.01
MMH262*	-	5/16" x 3" Carriage Bolt	0.01
MMB721	-	Nut 5/16" Hex.	0.01
KD001	-	3/8" Anchor Bolt	0.01

* 1 x **MMB721** is required for each **MMH254** and **MMH262**

CALL YOUR DISTRIBUTOR TODAY, FOR YOUR CUSTOM APPLICATION.

WIRE MESH PARTITION KITS

Customize KLETON products to your specs!
See Inside Front Cover



Rugged KLETON wire mesh partitions and enclosures provide maximum security at low cost for tools, valuable inventory, hazardous materials, and any area of your plant where restricted access is required. Bolt-down posts and reinforced panels provide the strength that your application demands.

Standard STOCK SIZES include all basic bolt-together hardware required for fast and easy installation of modular wall and roof panels, and a standard 4' x 8' or 8' x 8' sliding door which may be located on any side, opening left-to-right or right-to-left. This system provides the versatility needed to expand or modify your enclosure quickly and at minimum cost. Order an enclosure with a roof for maximum security. CUSTOM SIZES can be designed to suit your special application regardless of the size required. Colour: Kleton blue.

TYPE A - 2 SIDES

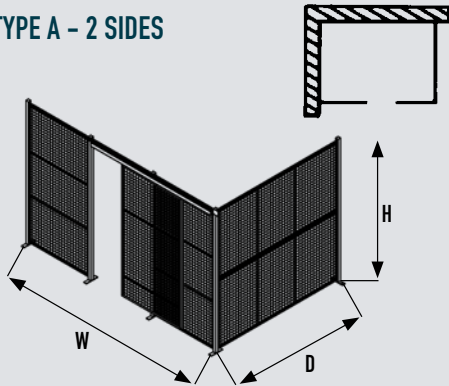

Unit Height	Overall Wall Size W x D	Standard Sliding Door Size W x H	WITHOUT ROOF		WITH ROOF	
			Model No.	Wt. lbs.	Model No.	Wt. lbs.
8'3"	12'8" x 8'4"	4' x 8'	KD069	417	KD070	670
8'3"	16'8" x 12'6"	4' x 8'	KD057	535	KD058	1009
8'3"	24'8" x 16'6"	8' x 8'	KD061	682	KD062	1485
12'3"	12'8" x 8'4"	4' x 8'	KD067	583	KD068	836
12'3"	16'8" x 12'6"	4' x 8'	KD055	758	KD056	1232
12'3"	24'8" x 16'6"	8' x 8'	KD059	977	KD060	1780

TYPE B - 3 SIDES

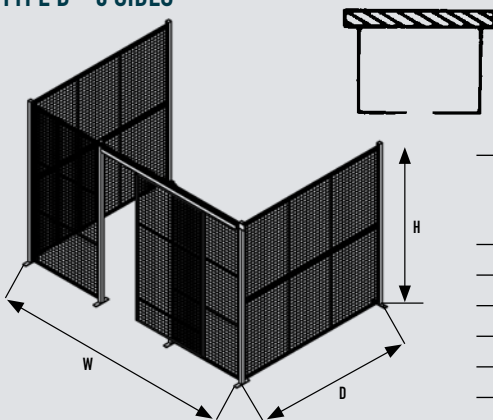

Unit Height	Overall Wall Size W x D	Standard Sliding Door Size W x H	WITHOUT ROOF		WITH ROOF	
			Model No.	Wt. lbs.	Model No.	Wt. lbs.
8'3"	12'8" x 8'4"	4' x 8'	KD085	511	KD086	758
8'3"	16'8" x 12'6"	4' x 8'	KD073	690	KD074	1158
8'3"	24'8" x 16'6"	8' x 8'	KD077	878	KD078	1677
12'3"	12'8" x 8'4"	4' x 8'	KD083	730	KD084	977
12'3"	16'8" x 12'6"	4' x 8'	KD071	997	KD072	1465
12'3"	24'8" x 16'6"	8' x 8'	KD075	1273	KD076	2072

TYPE C - 4 SIDES

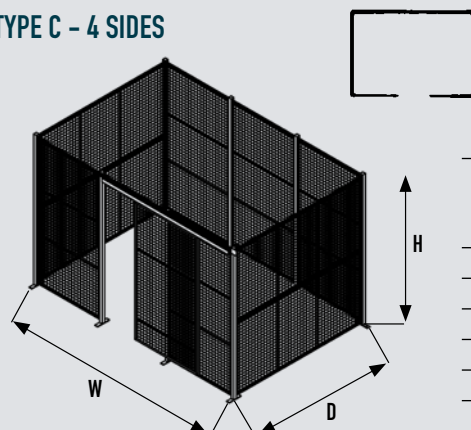

Unit Height	Overall Wall Size W x D	Standard Sliding Door Size W x H	WITHOUT ROOF		WITH ROOF	
			Model No.	Wt. lbs.	Model No.	Wt. lbs.
8'3"	12'8" x 8'4"	4' x 8'	KD101	688	KD102	923
8'3"	16'8" x 12'6"	4' x 8'	KD089	912	KD090	1368
8'3"	24'8" x 16'6"	8' x 8'	KD093	1190	KD094	1975
12'3"	12'8" x 8'4"	4' x 8'	KD099	996	KD100	1231
12'3"	16'8" x 12'6"	4' x 8'	KD087	1330	KD088	1786
12'3"	24'8" x 16'6"	8' x 8'	KD091	1740	KD092	2525



Customize KLETON products to your specs!
See Inside Front Cover

Rugged KLETON safety guards provide security and protection at low cost for tools, valuable inventory, hazardous materials, and any area of your plant where restricted access is required.

SAFETY GUARDS

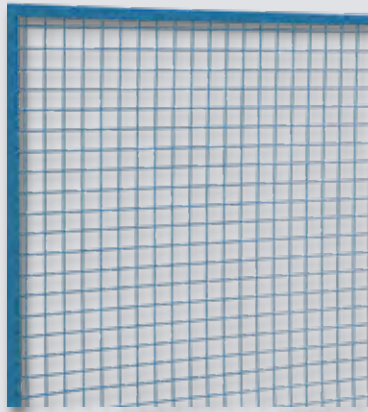

KD036

KD129



MESH STYLE INDIVIDUAL COMPONENTS

Blue Model No.	Yellow Model No.	Description	Dimensions	Wt. lbs.
KD036	KD139	Mesh Panel	4' H x 4' W	20
KD037	KD131	Mesh Panel	4' H x 8' W	39
KH861	KD129	Post Universal	49-1/2" H	13

HARDWARE REQUIRED

Model No.	Description
KD001	Floor Anchors (Two per Post)
MMH262	5/16" x 3" Carriage Bolt (Four per Frame)
MMH966	5/16" Hex Nut (One Nut for Each MMH262)
KD116	Post Caps (One per Post)



KH945

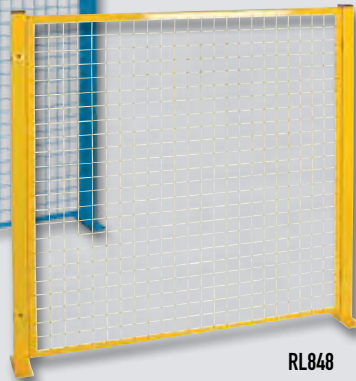

RL848

MESH STYLE KITS

- Create your own barrier guards with two styles to choose from: 2" x 2" welded wire mesh or 2" square tube
- Both feature a unique 49-1/2" overall height, and are easily installed
- Posts are constructed of 2" square tube with 5/16" base plate with holes for anchoring to floor
- Hardware to attach add-on sections is included
- Safety yellow or KLETON blue powder coat finish

Blue Model No.	Yellow Model No.	Description	Dimensions W" x H"	Wt. lbs.
KH945	RL848	Starter Section	48 x 48	46
KH946	RL849	Add-On Section	48 x 48	46
KH947	RL850	Starter Section	96 x 48	65
KH948	RL851	Add-On Section	96 x 48	55

Note: Includes assembly fasteners, floor anchors and post caps

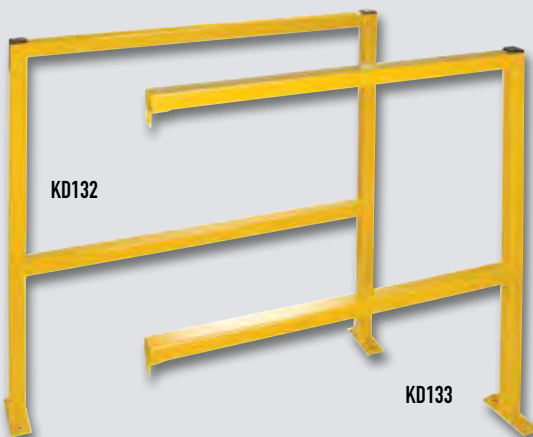

KD132

KD133

SQUARE TUBE STYLE KITS

Model No.	Safety Guards	Dimensions W" x H"	Wt. lbs.
KD132	Starter Section	48 x 49-1/2	45
KD133	Add-On Section*	46 x 49-1/2	32
KD134	Starter Section	96 x 49-1/2	66
KD135	Add-On Section*	94 x 49-1/2	53

*Hardware to attach add-on section is included

HARDWARE REQUIRED

KD001	Floor Anchors (2 Per Post)
KD116	Post Caps (1 Per Post)

RACKING PROTECTORS AND GUARD RAILS

Customize KLETON products to your specs!
See Inside Front Cover



STEEL RACKING AISLE PROTECTORS

- Prevent collision damage to shelving/racking from fork lifts, pallet trucks or other in-plant vehicle accidents
- Corner wraps are 12" high with an angle of 5" H x 3" W x 1/4" D with holes for anchoring to the floor
- Protectors can be customized to any other lengths and/or depths required
- Floor anchors not included
- Safety yellow powder coat finish



Model No.	Description	Fits Upright Width"	Overall Dimensions L" x W" x H"	Wt. lbs.
RN059	Single Wrap - Left	42	50-1/4 x 3 x 12	38
RN060	Single Wrap - Right	42	50-1/4 x 3 x 12	38
RN061	Single Wrap - Left	48	56-1/4 x 3 x 12	41
RN062	Single Wrap - Right	48	56-1/4 x 3 x 12	41
RN063	Double Wrap	42	46-1/2 x 3 x 12	46
RN064	Double Wrap	48	52-1/2 x 3 x 12	49

FLOOR ANGLE GUARD RAILS

- Floor angle guide rail helps keep traffic away from racking and shelving, walls, storage areas, offices, and other work areas
- The sturdy 5" H x 3" W x 1/4" D angle iron comes with holes to anchor to the floor
- Protectors can be customized to any other lengths and/or depths required
- Floor anchors not included
- Safety yellow powder coat finish



Model No.	Dimensions L" x W" x H"	Wt. lbs.
RN065	48 x 3 x 5	26
RN066	60 x 3 x 5	33
RN067	120 x 3 x 5	66

BOLLARDS, PROTECTORS & SAFETY GUARDS

SAFETY GUARDS

- Protect your equipment and personnel from accidental damage and injury
- 4" x 4" square tube welded to an 8" x 8" x 1/2" base, complete with four 3/4" diameter holes for anchoring to floor
- Safety yellow powder coat finish

Model No.	Dimensions L" x H"	Wt. lbs.
KD127	24 x 18	65
KH855	36 x 18	75
KD128	48 x 18	85
KD136	24 x 42	95
KD856	36 x 42	110
KD139	48 x 42	115

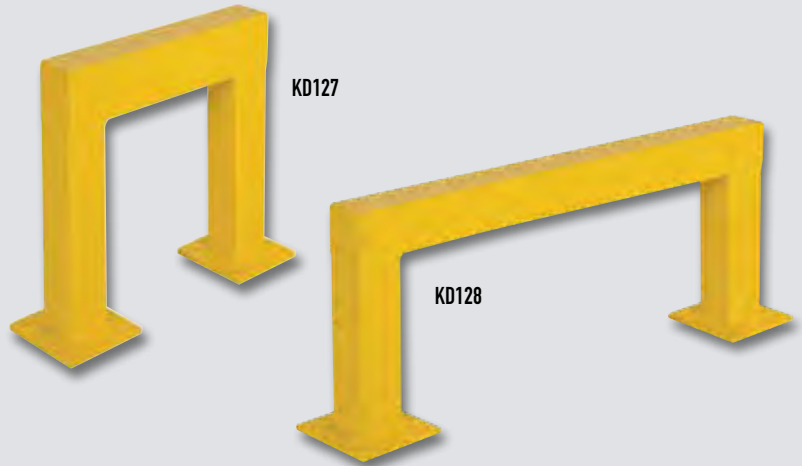

HEAVY-DUTY STEEL BOLLARDS

- Protect your warehouse equipment and high traffic areas
- 4" x 4" square tube welded to an 8" x 8" x 1/2" steel base complete with four 3/4" diameter holes for anchoring to floor
- Safety yellow powder coated finish

Model No.	Height	Wt. lbs.
KD125	24	30
KH857	36	40
KD126	48	50

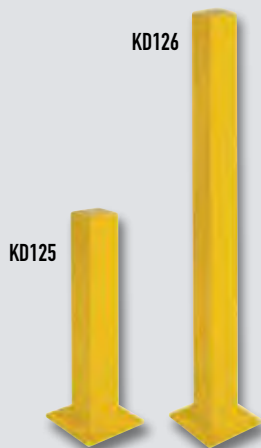

UPRIGHT PROTECTORS

- Protects industrial racking from damaging impacts that cause unsafe conditions
- Made from 1/4" thick steel
- Four pre-drilled holes made for 1/2" anchors (not included)
- Safety yellow powder coat finish

Model No.	Overall Dimensions W" x D" x H"	Wt. lbs.
RB925	7 x 7 x 18-1/4	15
KH858	7 x 7 x 12	12

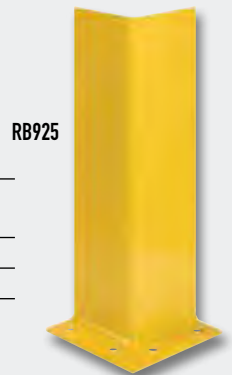

PALLET RACK BACK GUARDS

- Back guards help prevent accidents by keeping pallets or their contents from falling off the back. These guards increase safety where pedestrian pathways are behind the rack.
- Constructed using a 10-gauge frame, and 2" x 2" x 10-gauge wire mesh with stiffeners
 - Available in a variety of sizes to fit most pallet rack configurations
 - Guard brackets are designed to fit almost any style of rack
 - Safety yellow powder coated finish

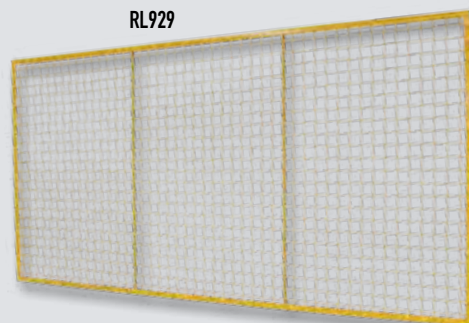

Model No.	Description	Wt. lbs.
RL929	Back Guard 4' x 8' w/6" Brackets	39
RL930	Back Guard 4' x 8' w/9" Brackets	40
RL931	Back Guard 4' x 8' w/12" Brackets	41
RL932	Back Guard 4' x 9' w/6" Brackets	49
RL933	Back Guard 4' x 9' w/9" Brackets	50
RL934	Back Guard 4' x 9' w/12" Brackets	51
RL935	Back Guard 4' x 10' w/6" Brackets	57
RL936	Back Guard 4' x 10' w/9" Brackets	58
RL937	Back Guard 4' x 10' w/12" Brackets	59
RL938	Back Guard 4' x 11' w/6" Brackets	63
RL939	Back Guard 4' x 11' w/9" Brackets	64
RL940	Back Guard 4' x 11' w/12" Brackets	65
RL941	Back Guard 4' x 12' w/6" Brackets	70
RL942	Back Guard 4' x 12' w/9" Brackets	71
RL943	Back Guard 4' x 12' w/12" Brackets	72

GUARD RAILS

MODULAR GUARD RAILS

- Modular design allows you to customize your guard rail system to meet your specific needs
- Durable powder coated safety yellow finish for better visibility

Model No.	Dimensions L" x W" x H"	Nominal Length"
KI237	19 x 3 x 12	24
KI238	31 x 3 x 12	36
KI239	43 x 3 x 12	48
KI240	55 x 3 x 12	60
KI241	67 x 3 x 12	72
KI242	79 x 3 x 12	84
KI243	91 x 3 x 12	96
KI244	103 x 3 x 12	108
KI245	115 x 3 x 12	120



SINGLE GUARD RAIL POST

- Modular design allows you to customize your guard rail system to meet your specific needs
- Durable powder coated safety yellow finish for better visibility
- Mounting hardware and plastic cap included, floor anchors and guard rails sold separately
- Dimensions: 5" L x 5" W x 17" H

Model No. **KI246**



DOUBLE GUARD RAIL POST

- Modular design allows you to customize your guard rail system to meet your specific needs
- Durable powder coated safety yellow finish for better visibility
- Mounting hardware and plastic cap included, floor anchors and guard rails sold separately
- Dimensions: 5" L x 5" W x 44" H

Model No. **KI247**



STRIP CURTAINS



EVERYTHING YOU NEED IN ONE PACKAGE TO INSTALL YOUR OWN STRIP CURTAIN DOOR AND SAVE MONEY!

ORDERING INFORMATION

Every strip curtain door comes complete with PVC strips and universal hardware for mounting strip curtain. Simple to follow installation instructions are included in every package.

1. Determine inside width and height of door opening.

NOTE: If mounting on door above lintel, measure from floor to mounting height.

2. Select type of PVC material required:

STANDARD or LOW TEMP.

Standard recommended for temperatures from -23°C to 66°C.

Low temp. recommended for interior use only for temperatures from -40°C to 66°C.

3. Select from the standard sizes listed in the chart below.

NOTE: If required size is not available, order the next largest size. Installation instructions describe how simple trimming can custom fit almost any door opening.

4. Special size doors and hanging applications are available upon request.

5. For overhead doors, please call one of our sales representatives for assistance.

EASY TO ORDER

It's easy to order the strip curtain that fits your door exactly because seven standard sizes can be made to fit 95% of most door openings. Special sizes are available.

IN-STOCK DELIVERY

We have the strip curtain package you need, in-stock, ready to be delivered to your door.

INTERIOR DOORS



Save energy costs

- The optimal solution to open door heat/cooling loss

Reduce noise pollution

- Provides the ideal accoustical barrier around noisy equipment

CONVEYORS

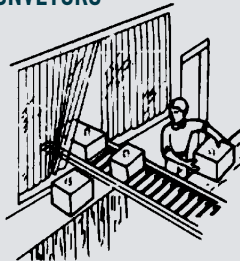

Provide extra safe passage

- People can see and be seen so there's less chance of accidents

Control smoke, dust and sprays

- Strip curtains can control in-plant contaminants to improve employee environment

DOCKS



Low maintenance

- Clear flexible vinyl resists stretching and stands up to abrasion
- All aluminum hardware is used for maximum durability
- May be quickly and easily cleaned with detergents or cleansing agents that are free from abrasives
- Deep stains and ingrained dirt etc. can be removed by carefully applying ethanol

STANDARD DOOR SIZES

Strip Size	Door Opening W' x H'	Model No. Standard	Model No. Low Temp.	Wt. lbs.
8" (8" x 0.080")	4 x 7	KF022	KF004	25
	5 x 8	KF023	KF005	35
	6 x 8	KF024	KF006	40
12" (12" x 0.120")	8 x 8	KF026	KF008	80
	8 x 10	KF025	KF007	100
	10 x 10	KF020	KF002	125
	12 x 12	KF021	KF003	175

NOTE: Doors with 8" strips have 2" standard overlap. Doors with 12" strips have 4" standard overlap.

REPLACEMENT STRIPS - 5 PER CARTON

Strip Size	Model No. Standard	Model No. Low Temp.	Wt. lbs.
8" x 0.080" x 8'	KF032	KF013	15
12" x 0.120" x 12'	KF029	KF011	45

BULK ROLLS

Strip Size	Roll'	Model No. Standard	Model No. Low Temp.	Wt. lbs.
8" x 0.080"	300	KI226	KI224	99
12" x 0.120"	200	KI225	KI223	150

NOTE: Rolls also available in dark amber welding material ML959

TARPAULINS

HEAVY DUTY CAMOUFLAGE TARPAULIN

- 10 x 10 weave density
- Water-resistant coating
- Reinforced polypropylene rope sewn in welded hems
- 150 micrometers (6 mil) thick
- Increased UV-resistance for long life
- Finished sizes may vary due to hem allowance

Model No.	Dimensions L' x W'
J1319	6 x 6
J1320	10 x 8
J1321	20 x 10
J1322	16 x 12
J1323	20 x 16
J1324	24 x 18
J1325	30 x 20
J1326	40 x 30



LIGHT INDUSTRIAL POLYETHYLENE TARPAULIN

- 14 x 14 weave density
- Water-resistant coating
- Reinforced polypropylene rope sewn in welded hems
- 200 micrometers (8 mil) thick
- Increased UV-resistance for long life
- Finished sizes may vary due to hem allowance

Model No.	Dimensions L' x W'
J1327	8 x 6
J1328	10 x 8
J1329	20 x 10
J1330	16 x 12
J1331	20 x 16
J1332	24 x 18
J1333	30 x 20
J1334	30 x 24
J1335	40 x 30
J1336	50 x 30
J1337	50 x 40
J1338	60 x 40



TARPAULINS

STANDARD-DUTY BLUE POLYETHYLENE

- 8 x 8 high density weave
- Reinforced polypropylene rope sewn in welded hems
- Heavy-duty rust-resistant grommets every 36"
- 100 micrometers (4 mils) thick
- Increased UV resistance for long life
- Water-resistant coating



Model No.	Dimensions L' x W'	Model No.	Dimensions L' x W'
NI768	5 x 7	NI775	18 x 24
NI769	6 x 8	NI776	20 x 30
NI770	8 x 10	NI777	24 x 30
NI771	10 x 12	NI778	30 x 40
NI772	10 x 20	JC510	30 x 50
NI773	12 x 16	JC511	40 x 50
NI774	16 x 20	NI779	40 x 60

HEAVY-DUTY WHITE POLYETHYLENE

- 10 x 10 high density weave
- Four corner rubber patches for added strength
- Reinforced polypropylene rope sewn in welded hems
- Heavy-duty rust-resistant grommets every 36"
- 150 micrometers (6 mils) thick
- Increased UV resistance for long life
- Water-resistant coating



Model No.	Dimensions L' x W'	Model No.	Dimensions L' x W'
NI780	6 x 8	JC513	20 x 30
NI781	8 x 10	NI785	24 x 30
NI782	10 x 12	JC514	30 x 40
NI783	12 x 16	JC515	30 x 50
NI784	16 x 20	JC625	40 x 50
JC512	18 x 24	JB508	40 x 60

INDUSTRIAL GREEN /SILVER POLYETHYLENE

- 14 x 14 high density weave
- 9" x 9" three layers on each corners for added strength
- Green on one side and silver on the other side for heat and ultraviolet light diversion
- Reinforced polypropylene rope sewn in welded hems
- Heavy-duty rust-resistant grommets every 20"
- 225 micrometers (9 mils) thick
- Increased UV resistance for long life
- Water-resistant coating

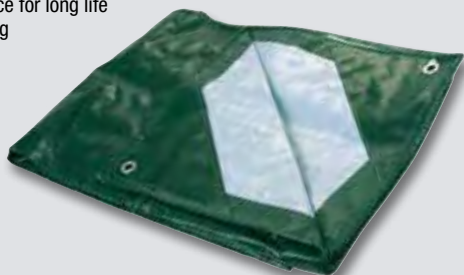

Model No.	Dimensions L' x W'	Model No.	Dimensions L' x W'
JB567	6 x 8	JB572	20 x 30
JB568	8 x 10	JC516	30 x 40
JB569	10 x 12	JC517	30 x 50
JB570	12 x 16	JC518	40 x 50
JB571	16 x 20	JB573	40 x 60

SUPER HEAVY-DUTY SILVER

- 16 x 16 high density weave
- Reinforced polypropylene rope sewn in welded hems
- Heavy-duty rust-resistant grommets every 30"
- 300 micrometers (12 mils) thick
- Increased UV resistance for long life
- Water-resistant coating
- 9" x 9" triple-layered on four corners



Model No.	Dimensions L' x W'	Model No.	Dimensions L' x W'
JC626	8 x 10	JC631	24 x 30
JC627	10 x 12	JC632	30 x 40
JC628	16 x 20	JC633	30 x 50
JC629	18 x 24	JC634	30 x 60
JC630	20 x 30	JC635	40 x 60

TARPAULINS, FURNITURE PADS & TIE DOWNS

CLEAR TARPAULINS

- Polyethylene tarpaulin with reinforced nylon gridding
- Water and mildew resistant coating
- Heavy-duty rust resistant grommets every 27"
- 3 x 3 high density weave
- 200 micrometers (8 mils) thick

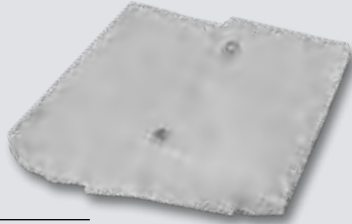

INSULATED TARPAULINS

- Lightweight and flexible, moisture resistant insulated tarpaulin
- Manufactured with 3/16" closed cell polyethylene foam insulation
- R-value is maintained in damp cold conditions
- Durable, water resistant polyethylene shell
- Heavy-duty rust resistant grommets every 2'
- R value: 1.0
- Dimensions: 12' x 20'



Model No. **JD420**

Model No.	Dimensions L' x W'
JD414	8 x 10
JD415	10 x 12
JD416	16 x 20
JD417	20 x 30
JD418	30 x 40
JD419	40 x 60

* Finished sizes slightly smaller due to hem allowance

ECONOMY FURNITURE PAD

- Protects furniture from scratches when moving
- Zig-zag stitching provides durability and consistent cushioning
- Dimensions: 80" x 72"
- Material: Cotton & Polyester
- Filling: 22 oz.



Model No. **PF797**

PREMIUM FURNITURE PADS

- Protect furniture from scratches when moving
- Zig-zag stitching provides durability and consistent cushioning
- Cotton and polyester material
- Filling: 40 oz.
- Size: 72" x 80"
- Weight: 5.5 lbs.
- Colour: Dark blue and light blue



Model No. **PF460**

STANDARD FURNITURE PADS

- Protect furniture from scratches when moving
- Zig-zag stitching provides durability and consistent cushioning
- Cotton and polypropylene material
- Filling: 29 oz.
- Size: 72" x 80"
- Weight: 5 lbs.
- Colour: Dark blue and green

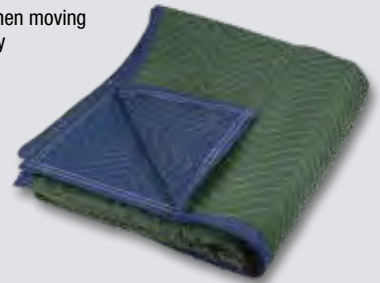

Model No. **PF461**

RUBBER TIE DOWNS

- Material: EPDM gives the ability to resist degradation resulting from weathering agents like UV rays and ozone making it perfect weather resistant rubber
- Retains its rebound qualities
- Rubber Tie Downs Straps resist cracking and rotting
- Durable Zinc plated steel "S" hooks



Model No.	Length"	Max. Safe Stretch"
PE366	5	7.5
PE367	9	13.5
PE368	15	22.5
PE369	21	31.5
PE370	31	46.5
PE371	41	61.5

RUBBER TIE DOWN SETS

Same great features as KLETON rubber tie downs however in the convenience of sets!

10-PC. BASIC TIE DOWN SET

- Set Includes:
- 4 - 21" tie downs (**PE369**)
 - 2 - 31" tie downs (**PE370**)
 - 4 - 41" tie downs (**PE371**)

Model No. **PF090**

16-PC. ALL-PURPOSE TIE DOWN SET

- Set Includes:
- 2 - 9" tie downs (**PE367**)
 - 2 - 15" tie downs (**PE368**)
 - 4 - 21" tie downs (**PE369**)
 - 4 - 31" tie downs (**PE370**)
 - 4 - 41" tie downs (**PE371**)

Model No. **PF091**

20-PC. PROFESSIONAL TIE DOWN SET

- Set Includes:
- 10 - 21" tie downs (**PE369**)
 - 10 - 41" tie downs (**PE371**)

Model No. **PF092**



DRUM HANDLING EQUIPMENT

Drum Stacking Racks.....	140
Drum Grabber.....	140
Drum Rockers.....	141
Can Tipper.....	141
Drum Lifting Hook.....	141
All-in-One Drum Trucks.....	142
Drum Hand Trucks.....	142
Low Profile Drum Truck.....	143
Drum Dollies.....	143

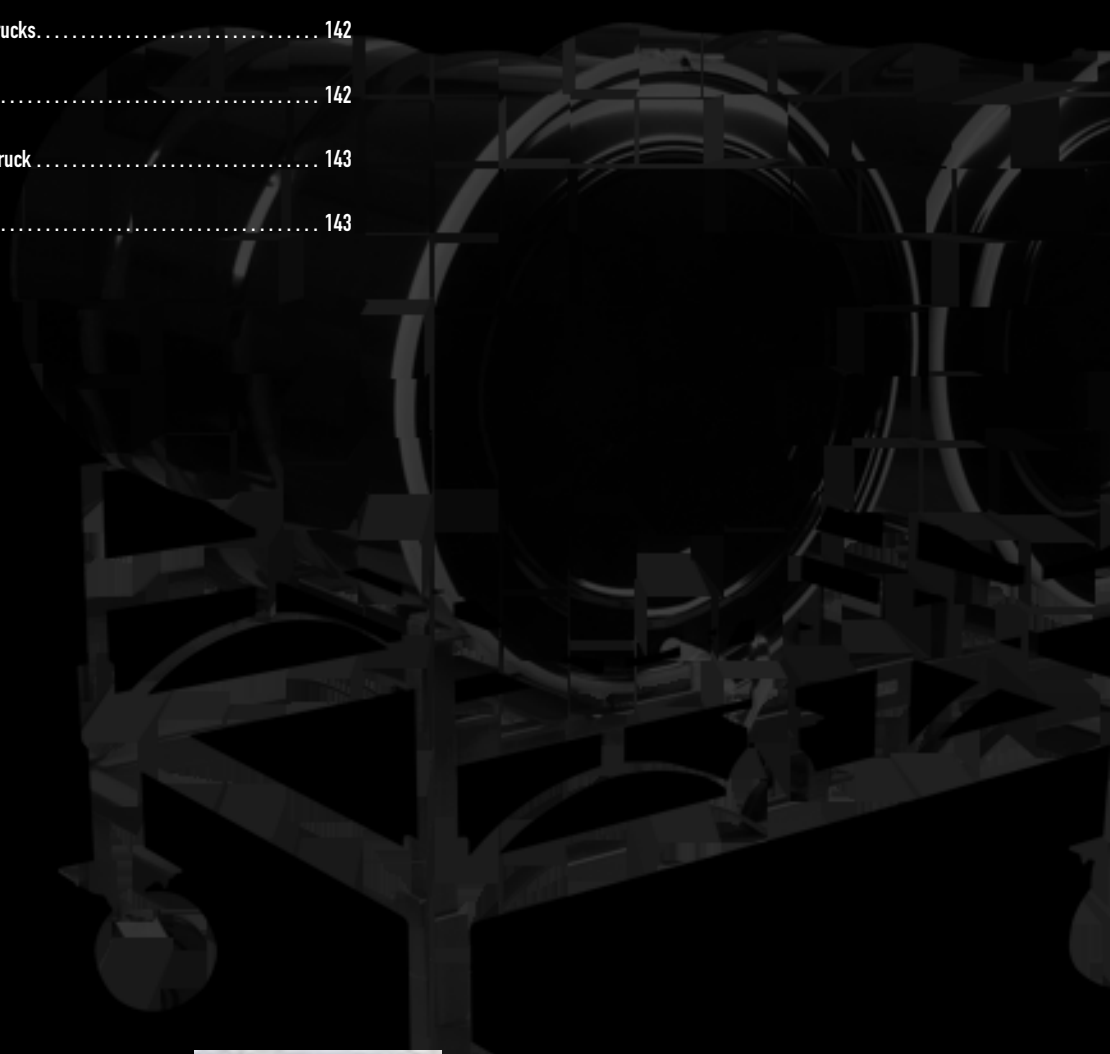

DRUM HANDLING EQUIPMENT

DRUM STACKING RACKS

- Rack holds two or three 45 imp. gal./55 US gal. drums
- Can be stacked up to three high
- Conveniently stacks drums horizontally increasing space efficiency
- Forklift access from all four sides
- Durable Kleton blue enamel finish
- Shipped knocked down

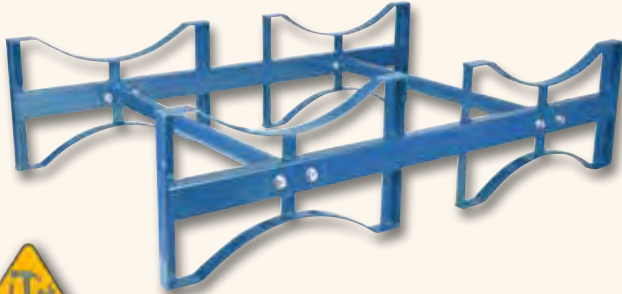

Model No.	Drum Cap.	Overall Dimensions W" x D" x H"	Max Capacity lbs.*	Wt. lbs
DC262	2	45-1/2 x 30 x 12-1/2	1600	48
DC263	3	71-1/2 x 30 x 12-1/2	2400	75

* The total weight capacity for all drums and racks being stacked.

DRUM STACKING RACK DOLLIES

- All welded, ready to use
- Dolly allows stacking racks to be mobile
- Two rigid and two swivel casters
- Durable Kleton blue enamel finish
- Caster assembly required

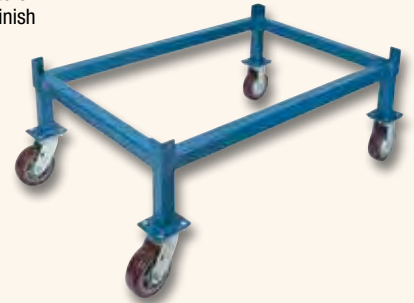

Model No.	Wheel Type	Overall Dimensions W" x D" x H"	Capacity lbs.
DC392	6" Hi-Temp Nylon	46 x 30 x 9	1600
DC393	6" Polyurethane	46 x 30 x 9	1600

REPLACEMENT PARTS

Model No. **ML861**, 6" Hi-Temp Nylon Swivel Caster

Model No. **ML862**, 6" Hi-Temp Nylon Rigid Caster

Model No. **ML399**, 6" Polyurethane Swivel Caster

Model No. **ML400**, 6" Polyurethane Rigid Caster



Drip Pan and Faucet
Not Included
DC386



DRUM STACKING RACK AND DOLLY KITS

Model No.	Wheel Type	Overall Dimensions W" x D" x H"	Capacity lbs.
DC386	6" Hi-Temp Nylon	46 x 30 x 21-1/2	1600
DC387	6" Polyurethane	46 x 30 x 21-1/2	1600

STEEL DRUM GRABBER

- Lift and transport one 45 imp./55 US gal. steel drum without the fork truck driver leaving his seat
- No risk of drum slipping since handler grips under rim of drum or rolling hoops
- Heavy gauge grabber slides onto truck forks and is locked with two turn down screws

1000-LB.
CAPACITY



Model No.	Description	Fork Pocket Inner Dim. W" x H"	Capacity lbs. /Drum
DC424	Single Drum Grabber	5-1/2 x 2	1000

DRUM HANDLING EQUIPMENT

ALL-WELDED DRUM ROCKER

- All-welded heavy-gauge 1-1/4" steel tubing construction
- Safe method of upending up to 45 imp. gal./55 US gal. drums for moving, draining or storing
- No lifting, straining or danger of drum tipping backwards
- Load drum into the draining position in seconds
- Removable handle
- Durable Kleton blue enamel finish



**1000-LB.
CAPACITY**

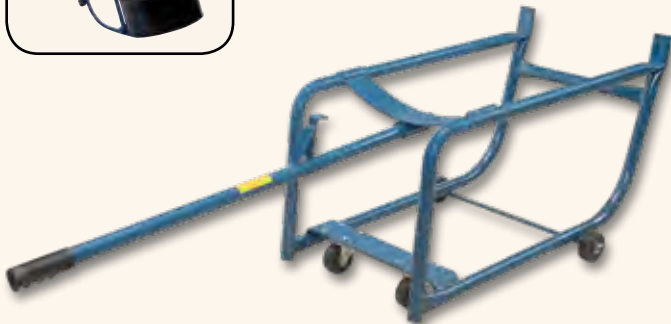

Model No.	Description	Overall Dimensions W" x D" x H"	Wt. lbs.
DC442	Drum rocker with two 3" swivel casters & two 3" rigid wheels	33 x 22 x 20	38

KNOCKED-DOWN DRUM ROCKERS

- Safe method for moving, draining and storing 45 imp. gal./55 US gal. drums
- Two 3" non-sparking wheels and two 3" non-sparking swivel casters
- Removable handle
- Powder coat finish
- Shipped knocked down

**700-LB.
CAPACITY**

CAUTION: Clamping bracket on handle must be used when maneuvering unit.

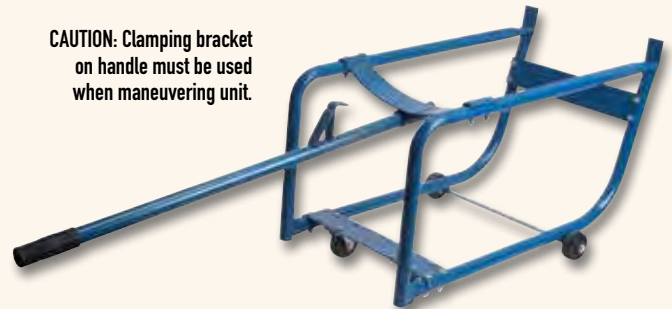

Model No.	Description	Overall Dimensions W" x D" x H"	Wt. lbs.
DC443	Rocker with two 3" non-sparking wheels and two 3" non-sparking swivel casters	33 x 22 x 20	34

REPLACEMENT PARTS

Model No. **DC464**, 3" Polyolefin Wheel

Model No. **DC463**, 3" Polyolefin Swivel Caster

Model No. **DC473**, Handle & Black Plastic Handle Grip

CAN TIPPER

- Handles 4 imp. gal./5 US gal. round pails
- Safety lever holds container in place
- Dispensing height of 11-1/2"
- Capacity: 75 lbs.
- Weight: 10 lbs.
- Shipped knocked down

Model No. **DC472**



DC472

DRUM LIFTING HOOK

- Horizontally lifts 45 imp. gal./55 US gal. steel drums, 34" - 36" long
- Alloy steel lifting ring, steel rods, malleable iron hooks
- Capacity: 1000 lbs.
- Weight: 5 lbs.

Model No. **DC449**

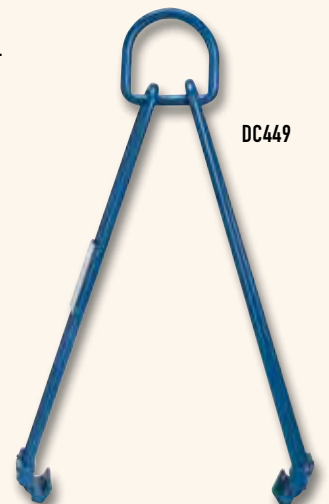

DC449



DRUM HANDLING EQUIPMENT

ALL-IN-ONE DRUM TRUCKS

- All-welded, 1-1/4" round tubular steel frame
- Can be used to transport and dispense drums
- Easy-to-use belt-system and hook keeps drums securely on the truck
- Easy to load and unload on skids
- Handles plastic steel or fibre drums
- Loop handle models provides added leverage while dual handle models provide side body comfort
- Four wheel design for added support and easy manoeuvrability
- Durable Kleton blue enamel finish



Retaining Hook



1200-LB. CAPACITY

Model No.	Handle Type	Wheel Type	Wt. lbs.
DC266	Loop	10" Mold-On Rubber	64
DC267	Loop	10" Pneumatic	58
DC256	Dual	10" Mold-On Rubber	62
DC257	Dual	10" Pneumatic	56

REPLACEMENT PARTS

- Model No. **ML069**, 10" Pneumatic Wheel
 Model No. **MN694**, 10" Mold-on Rubber Wheel
 Model No. **PF805**, 2" Pull Strap

HAND TRUCK FOR PLASTIC AND FIBRE DRUMS

- All-welded, 1-1/4" round tubular steel frame
- Handles plastic and fibre drums from 18" to 25" in diameter and 24" to 41" in height
- 2" ratchet strap secures drum in place
- Rolls on 10" front and 6" rear rubber-tired wheels
- Durable Kleton blue enamel finish



1000-LB. CAPACITY

Model No.	Description	Overall Dimensions W" x D" x H"	Wt. lbs.
DA595	Truck for plastic and fibre drums	24 x 22 x 58	56

REPLACEMENT PARTS

- Model No. **MH296**, 6" Mold-on Rubber Wheel
 Model No. **MN694**, 10" Mold-on Rubber Wheel
 Model No. **MA382**, Black Plastic Handle Grip
 Model No. **PF805**, 2" Pull Strap



DA594

1000-LB. CAPACITY

DRUM HAND TRUCKS

- All-welded 1-1/4" round tubular steel frame
- Handles containers from as small as 18" in diameter to large 55-gallon steel drums
- Ideal for loading drums onto pallets, or for going over curbs or uneven docks
- Free standing when loaded
- Durable Kleton blue enamel finish

Model No.	Description	Overall Dimensions W" x D" x H"	Wt. lbs.
DA593	Truck with 10" front rubber wheels only	24 x 19 x 58	44
DA594	Truck with 10" front and 6" rear rubber wheels	24 x 22 x 58	50

REPLACEMENT PARTS

- Model No. **MH296**, 6" Mold-on Rubber Wheel
 Model No. **MN694**, 10" Mold-on Rubber Wheel
 Model No. **MA382**, Black Plastic Handle Grip

DRUM HANDLING EQUIPMENT

LOW PROFILE DRUM TRUCK

- All-welded steel construction with 8" x 2" rubber wheels and 4" non-marking rubber swivel casters for smooth movement and easy manoeuvrability
- Ideal for moving full, open top 45 imp. gal./55 US gal. drums without spilling contents
- With a low-level frame, only 1" from the ground, this truck allows for easy loading of drums
- Hinged handle moves forward and backward for easy pushing or pulling
- Quality powder coat finish
- Shipped knocked down

1000-LB. CAPACITY



Model No.	Overall Dimensions W" x D" x H"	Overall Handle Length"	Wt. lbs.
DC500	30 x 24 x 46	39	44



REPLACEMENT PARTS

Model No. **ML333**, 4" Non-Marking Rubber Swivel Caster

Model No. **ML813**, 8" Mold-on Rubber Wheel

Model No. **DC502**, Black Plastic Handle Grip

STEEL ROUND FRAME DRUM DOLLIES

- Welded 3/16" thick x 4", frames are built to withstand constant use
- 24" inside diameter handles 45 imp. gal./55 US gal. drums
- Comes with four swivel casters
- Quality powder coat finish
- Shipped knocked down



Model No.	Caster Type	Caster Size"	Caster Height"	Capacity lbs.	Wt. lbs.
DC202	Polyolefin	3	4-1/2	750	21
DC199	Polyurethane	3	4-1/2	1000	24
DC200	Polyurethane	4	5-1/2	1500	27
DC070	Frame Only	(Fits caster hole spacings of 1-5/8" x 3" to 2-3/4" x 3-1/4")			16

REPLACEMENT PARTS

Model No. **ML391**, 3" Polyolefin Swivel Caster

Model No. **ML044**, 3" Polyurethane Swivel Caster

Model No. **ML045**, 4" Polyurethane Swivel Caster

STEEL X-FRAME DRUM DOLLIES

- Welded 3/16" thick x 4", frames are built to withstand constant use
- 24" inside diameter handles 45 imp. gal./55 US gal. drums
- Comes with four swivel casters
- Quality powder coat finish
- Shipped knocked down

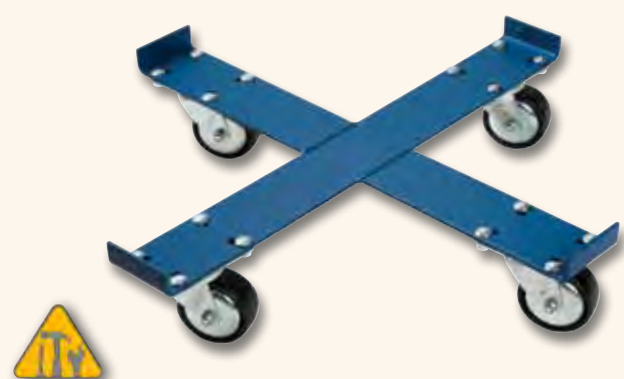

Model No.	Caster Type	Caster Size"	Caster Height"	Capacity lbs.	Wt. lbs.
DC206	Polyolefin	3	4-1/2	750	13
DC203	Polyurethane	3	4-1/2	1000	16
DC204	Polyurethane	4	5-1/2	1500	19
DC071	Frame Only	(Fits caster hole spacings of 1-5/8" x 3" to 2-3/4" x 3-1/4")			8

REPLACEMENT PARTS

Model No. **ML391**, 3" Polyolefin Swivel Caster

Model No. **ML044**, 3" Polyurethane Swivel Caster

Model No. **ML045**, 4" Polyurethane Swivel Caster



DRUM PUMPS & ACCESSORIES

Drum Accessories	145
Drum Faucets	145
Drum Valves	145
Drum Vents	145
Bung Nut Wrenches	145
Drum Pumps	146 - 150
Water Pumps	151 - 152

WARNING! Chemical compatibility of a drum or barrel pump should be checked for EACH LIQUID BY CHEMICAL NAME! Please contact your KLETON representative for chemical compatibility. No single drum pump can be universally chemical resistant. Some blends of chemicals may not be suitable for any of these drum pumps. Remember to have your MSDS for each chemical that will be dispensed when calling your KLETON representative. We will be able to help you select the right pump for your application.

DRUM ACCESSORIES

SELF-CLOSING GATE VALVE

- For use with viscous non-corrosive fluids heavier than SAE30 motor oil
- Heavy-duty brass construction
- Self-closing PTFE blade has fast, positive shut off when handle is released
- 4-1/2" wide handle
- Wide opening permits maximum flow
- Fits 2" bung in steel or plastic drums
- Weight: 7 lbs.



Model No. PE363

SELF-CLOSING FAUCET WITH SCREEN

- Flame arrester safety faucet
- Standard 3/4" tapered pipe thread
- Can be padlocked closed
- Natural zinc die cast finish
- Weight: 1 lbs.



Model No. PE364

SELF-CLOSING FAUCET

- For non-flammable liquids only
- No flame arrester
- 3/4" pipe thread
- Can be padlocked closed
- Natural zinc die cast finish
- Weight: 0.5 lbs.



Model No. PE365

HORIZONTAL BRASS VENT

- Horizontal vents are for use with drums in the horizontal pouring position
- Automatically relieves pressure at 5 PSI
- Flame arrester prevents sparks and flame from igniting contents
- Manual vacuum relief by lifting and rotating the valve stem
- Maximum flow of 220 CFM at 20 PSI
- Fits 2" NPS bung in steel or plastic drums
- Weight: 1 lbs.

Model No. PE362



BUNG NUT WRENCHES

- Fits almost any metal or plastic, male or female bung nuts or plugs
- Offset handle
- 13" overall length
- Weight: 4 lbs.

Model No. DA638

Constructed of: Annealed ductile iron

Model No. DA637

Constructed of: Non-sparking, manganese bronze alloy

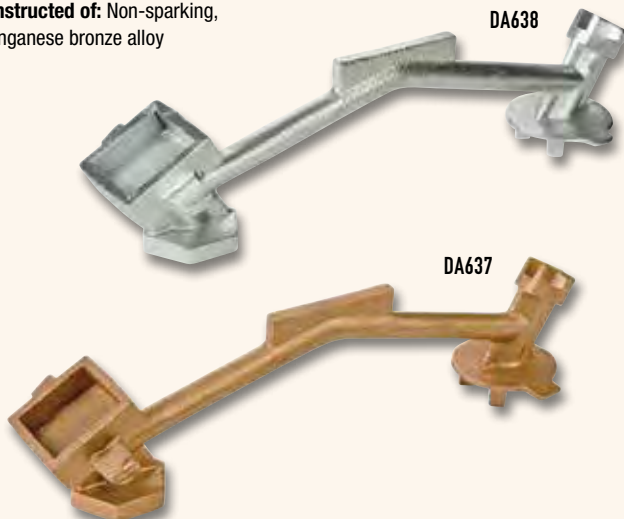

DELUXE PLUG WRENCH

- Non-sparking brass alloy wrench fits virtually all industrial drums including those with square or hex plugs, male or female bung nuts or plugs and fittings with lugs and crossbars
- Built-in 1-1/4" wrench for tightening faucets into drums; eliminates the need for extra tools
- Weight: 2 lbs.

Model No. PE359



DRUM PUMPS

WARNING! Chemical compatibility of a drum or barrel pump should be checked for EACH LIQUID BY CHEMICAL NAME! Please contact your KLETON representative for chemical compatibility. No single drum pump can be universally chemical resistant. Some blends of chemicals may not be suitable for any of these drum pumps. Remember to have your MSDS for each chemical that will be dispensed when calling your KLETON representative. We will be able to help you select the right pump for your application.

STAINLESS STEEL PULL TYPE DRUM PUMPS

Wetted components:

304 stainless steel, brass, polyethylene and steel.

- Use with certain acids and alkalis
- Fits 5 to 55-gallon drums with a 2" bung adaptor
- Transfer rate: 8 oz. per stroke

Model No. **DA530**



Wetted components:

304 stainless steel, 316 stainless steel, brass and PTFE.

- For most acids and corrosives
- Fits 5 to 55-gallon drums with a 2" bung adaptor
- Transfer rate: 8 oz. per stroke

Model No. **DA531**



Wetted components:

304 stainless steel, polyethylene and PTFE.

- For fast transfer of most acids and corrosives
- Fits 55-gallon drums with a 2" bung adaptor
- Transfer rate: 22 oz. per stroke

Model No. **DA529**



Wetted components:

304 stainless steel, 316 stainless steel and PTFE.

- For fast transfer of most acids and corrosives
- Fits 55-gallon drum with a 2" bung adaptor
- Transfer rate: 22 oz. per stroke

Model No. **DB845**



STEEL PULL TYPE DRUM PUMPS

Wetted components:

Brass, steel and polyethylene.

- For most non-corrosive and non-flammable liquids
- Fits 5 to 55-gallon drums with a 2" bung adaptor
- Transfer rate: 8 oz. per stroke

Model No. **DA527**



Wetted components:

Buna-N, polyethylene, leather and steel.

- For most water-soluble inorganic acids, waxes, detergents
- Fits 5-gallon pails with a 2" bung adaptor
- Transfer rate: 8 oz. per stroke

Model No. **DC113**



Wetted components:

Polyethylene, steel and zinc.

- Use with most non-corrosive, light to medium viscosity liquids
- Fits 55-gallon drum with a 2" bung adaptor
- 3/4" diameter spout can be rotated to 180° and removed to expose garden hose thread
- Transfer rate: 22 oz. per stroke

Model No. **DC114**



ALUMINUM DIAPHRAGM HAND PUMPS

Wetted components:

Aluminum, Buna-N, Poly Acetal, 304 stainless steel and steel.

- For use with most motor oil and other light petroleum products
- Fits 15 to 55-gallon drums with 2" bung adaptor
- Transfer Rate: 25.5 oz. per stroke
- Includes a safety locking latch

Model No. **DC068**



WARNING! Chemical compatibility of a drum or barrel pump should be checked for EACH LIQUID BY CHEMICAL NAME! Please contact your KLETON representative for chemical compatibility. No single drum pump can be universally chemical resistant. Some blends of chemicals may not be suitable for any of these drum pumps. Remember to have your MSDS for each chemical that will be dispensed when calling your KLETON representative. We will be able to help you select the right pump for your application.

DRUM PUMPS

PULL TYPE DRUM PUMPS

POLYPROPYLENE

Wetted components:

Polyethylene, polypropylene, silicone and steel.

- For use with most corrosive chemicals and non-flammable solvents
- Fits 5 to 55-gallon drums with 3/4" or 2" bung adaptor
- 360° discharge spout orientation
- Transfer rate: 16 oz. per stroke

Model No. **DC115**



Wetted components:

Polypropylene, steel and Viton®.

- For use with most antifreeze, detergents, windshield fluids, glycerin, and mild acids
- Fits 15 to 55-gallon drums with 2" bung adaptor
- Transfer rate: 14 oz. per stroke

Model No. **DC127**



Wetted components:

Polyethylene, polypropylene and nylon.

- For use with most corrosive chemicals, water, and non-flammable solvents
- Good insulation from spark and fire
- Fits 55-gallon drums with a 2" bung adaptor
- Transfer rate: 22 oz. per stroke

Model No. **DC117**



Wetted components:

Polypropylene, polyethylene, silicone and steel.

- For use with most corrosive chemicals and non-flammable solvents
- Adapts to 3/4" or 2" bung adaptor for 5 to 55-gallon drums
- 360° discharge spout orientation
- Transfer rate: 8 oz. per stroke

Model No. **DA532**



PVC

Wetted components:

Polypropylene, nylon, PVC and Viton®.

- For use with most mild acids, detergents, water and solvents
- Good insulation from spark and fire
- Adapts to 3/4" or 2" bung adaptor for 5 to 55-gallon drums
- Transfer rate: 8 oz. per stroke

Model No. **DC116**



Wetted components:

PVC, nylon and Viton®.

- For use with most mild acids, detergents, water and solvents
- Good insulation from spark and fire
- Fits 55-gallon drums with a 2" bung adaptor
- Transfer rate: 22 oz. per stroke

Model No. **DC118**



NYLON

Wetted components:

Polypropylene, nylon, 304 stainless steel and PTFE.

- For use with most lacquer thinners, mild acids, detergents, water and light viscosity petroleum liquids
- Fits 15 to 55-gallon drums with 2" bung adaptor
- Transfer rate: 14 oz. per stroke

Model No. **DC128**



DRUM PUMPS

WARNING! Chemical compatibility of a drum or barrel pump should be checked for EACH LIQUID BY CHEMICAL NAME! Please contact your KLETON representative for chemical compatibility. No single drum pump can be universally chemical resistant. Some blends of chemicals may not be suitable for any of these drum pumps. Remember to have your MSDS for each chemical that will be dispensed when calling your KLETON representative. We will be able to help you select the right pump for your application.

ROTARY LOBE PUMP OVERVIEW

Lobe pumps are popular in diverse industries because they offer superb sanitary qualities, high efficiency, reliability, corrosion resistance and good clean-in-place and sterilize-in-place characteristics.

Rotary lobe pumps are non-contacting and have large pumping chambers. If wetted, they offer self-priming performance. A gentle pumping action minimizes product degradation. They also offer reversible flows and can operate dry for long periods of time.

Advantages:

- Pass medium solids
- No metal-to-metal contact
- Superior CIP/SIP capabilities
- Long term dry run (with lubrication to seals)
- Non-pulsating discharge

Wetted components:

Aluminum, Buna-N, cast iron, chrome plated, polypropylene, steel and zinc.

- For use with most low viscosity and non-corrosive petroleum based fluids
- Dual directional operation for rapid discharge
- Fits 55-gallon drums with a 2" bung adaptor
- Transfer rate: 1 liter per revolution

Model No. **DC111**



LEVER TYPE DRUM PUMPS

Wetted components:

304 stainless steel, chrome plated, polyethylene, polypropylene and Viton®.

- Use with certain water-based solvents, mild acids and light viscosity petroleum liquids
- Adapts to 1-1/2" or 2" bung adaptor for 5 to 55-gallon drums
- Transfer rate: 14 oz. per stroke

Model No. **DC121**



Wetted components:

- 316 stainless steel, polypropylene, polyphenylene sulfide and PTFE.
- Use with most water-based solvents, strong acids or alkalis and light viscosity petroleum liquids
- Adapts to 1-1/2" or 2" bung adaptor for 5 to 55-gallon drums
- Transfer rate: 14 oz. per stroke

Model No. **DC12**



Wetted components:

316 stainless steel and PTFE.

- Use with certain water-based solvents, strongest acids or alkaline solutions
- Adapts to 1-1/2" or 2" bung adaptor for 5 to 55-gallon drums
- Transfer rate: 14 oz. per stroke

Model No. **DC123**



Wetted components:

- Brass, Buna-N, polyethylene, steel and zinc.
- Use with most dispensing and transferring non-corrosive and petroleum based fluids
- Cushioned vinyl grip handle
- Discharge spout can be rotated 180° and removed to expose garden hose threaded outlet
- Adapts to 1-1/2" or 2" bung adaptor for 30 to 55-gallon drums
- Transfer rate: 11 oz. per stroke

Model No. **DC124**



POLYETHYLENE SIPHON PUMPS

Wetted components:

Polyethylene

- Use for most water based liquids, light oils and detergents
- Air vent in handle controls flow
- Fits 5-gallon pails
- Transfer rate: 2 gallons/minute

Model No. **DC120**



Wetted components:

Polyethylene

- Use with water based liquids, light oils and detergents
- Air vent in handle controls flow
- Fits 15 to 55-gallon drums with 2" bung adaptor
- Transfer rate: 7 gallons/minute

Model No. **DC119**

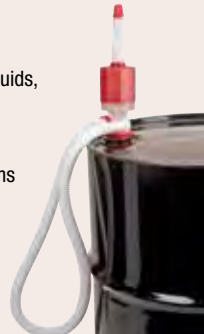

PAIL TYPE PUMP

Wetted components:

Delrin®, polyethylene, PVC and steel.

- For use with most engine oils, gear oils and antifreeze
- Fits 5 gallon pails
- Includes a 48" discharge hose fitted with curved metal spout at discharge end
- Transfer rate: 2 oz. per stroke
- Comes with a Rieke® adaptor

Model No. **DC129**



WARNING! Chemical compatibility of a drum or barrel pump should be checked for EACH LIQUID BY CHEMICAL NAME! Please contact your KLETON representative for chemical compatibility. No single drum pump can be universally chemical resistant. Some blends of chemicals may not be suitable for any of these drum pumps. Remember to have your MSDS for each chemical that will be dispensed when calling your KLETON representative. We will be able to help you select the right pump for your application.

DRUM PUMPS

ROTARY TYPE DRUM PUMPS ROTARY VANE PUMP OVERVIEW

While vane pumps can handle moderate viscosity liquids, they excel at handling low viscosity liquids such as LP gas (propane), ammonia, solvents, alcohol, fuel oils, gasoline and refrigerants. Vane pumps have no internal metal-to-metal contact and self-compensate for wear, enabling them to maintain peak performance on these non-lubricating liquids. Vane pumps are noted for their dry priming, ease of maintenance, and good suction characteristics over the life of the pump.

ADVANTAGES

- Handles thin liquids at relatively higher pressures
- Compensates for wear through vane extension
- Sometimes preferred for solvents, LP gas
- Can run dry for short periods
- Can be equipped with a gasket or a stuffing box
- Develops good vacuum

ALUMINUM

Wetted components:

Aluminum, Buna-N, PVC nitrile, steel and zinc.

- For use with most low viscosity, non-corrosive petroleum based fluids and lubricating oils up to SAE30
- Fits 15 to 55-gallon drums with a 2" bung adaptor
- Transfer rate: 6-3/4 oz. per revolution
- Includes a safety locking latch
- 3/4" dia. x 1.8 m long PVC nitrile discharge hose included

Model No. **DC126**



POLYPROPYLENE

Wetted components:

304 stainless steel, polypropylene, PTFE and Viton®, PVDF

- For water-soluble inorganic acids, waxes, detergents
- Fits 15 to 55-gallon drums with a 2" bung adaptor
- Transfer rate: 8 oz. per revolution

Model No. **DB998**



Wetted components:

Aluminum, Buna-N, polypropylene and steel.

- For use with most medium viscosity petroleum fluid, and non-corrosive fluids
- Fits 15 to 55-gallon drums with a 2" bung adaptor
- Transfer rate: 8 oz. per revolution

Model No. **DC112**



POLYPHENYLENE SULFIDE AND STAINLESS STEEL

Wetted components:

304 stainless steel, PVDF, polyphenylene sulfide and PTFE.

- Use with most aggressive chemicals such as hydrocarbons and ketones
- Fits 15 to 55-gallon drums with a 2" bung adaptor
- Transfer rate: 12 oz. per revolution

Model No. **DC335**



STEEL AND CAST IRON

Wetted components:

Buna-N, cast iron, polyethylene, polypropylene and steel.

- For use with most medium viscosity petroleum fluid, light non-flammable and non-combustible fluids
- Dual directional operation allows pump to both empty and refill containers
- Fits 30 to 55-gallon drums with a 2" bung adaptor
- Transfer rate: 8 oz. per revolution
- Steel discharge spout and polyethylene discharge hose of 1" diameter and 55" long included

Model No. **DA528**



DC098
Polyethylene
discharge hose



DRUM PUMPS

WARNING! Chemical compatibility of a drum or barrel pump should be checked for EACH LIQUID BY CHEMICAL NAME! Please contact your KLETON representative for chemical compatibility. No single drum pump can be universally chemical resistant. Some blends of chemicals may not be suitable for any of these drum pumps. Remember to have your MSDS for each chemical that will be dispensed when calling your KLETON representative. We will be able to help you select the right pump for your application.

PTFE

Wetted components:

304 Stainless Steel, PVDF and PTFE.

- For most aggressive chemicals such as acids and alkalines
- Fits 30 to 55-gallon drums with a 2" bung adaptor
- Transfer rate: 12 oz. per revolution

Model No. **DB997**



STAINLESS STEEL

Wetted components:

304 stainless steel, PVDF and PTFE.

- For most organic acids, alcohols and solvents
- Fits 15 to 55-gallon drums with a 2" bung adaptor
- Transfer rate: 12 oz. per revolution

Model No. **DB759**



FM APPROVED ALUMINUM & CAST IRON ROTARY PUMP

Wetted components:

Cast iron, steel, graphite, polypropylene, aluminum, EPDM rubber and Buna-N

- FM approved pump with 8' antistatic hose, nozzle, flame arrestor and vacuum breaker
- For use with class 1 and class 2 flammable and combustible liquids such as gasoline, alcohols, and other solvents
- Fits 15 to 55-gallon drums with a 2" bung adaptor
- Transfer rate: 10 gallons per minute

Model No. **DC505**

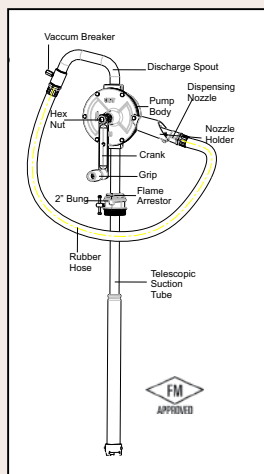

FM APPROVED PULL TYPE DRUM PUMP

Wetted components:

316 Stainless Steel, PTFE

- For fast transfer of most solvents, acids and corrosives chemicals
- WARNING! Chemical compatibility of a drum or barrel pump should be checked for EACH LIQUID BY CHEMICAL NAME! Please contact your representative for chemical compatibility
- Fits 15-55-gallon drums with a 2" bung adaptor
- Pump body made from 316 Stainless Steel with PTFE Piston & PTFE Sealing Gasket
- Heavy-Duty bonding and grounding wires prevent hazardous static charge
- Wires are secured by locknut and have heavy-duty alligator clips
- Built-in internal flame arrestor prevents flame flashback
- Fits Gallon Size: 55 Gal.
- Body Material: Stainless Steel

Model No. **DC765**



PUMP SPECIFICATIONS

Inlet / Outlet	3/4" NPT (F)
Flow	38 LPM (10 GPM) @120 RPM
Maximum Fluid temperature	250°F/ 120°C
Mounting	2" MNPT Bung Adapter
Maximum Viscosity	2000 SSU
Suction Tube Length	18.2" (460mm) to 34.5"(875mm)



WATER PUMPS

SUBMERSIBLE UTILITY PUMP

- Voltage: 115 V
- Continuous duty and easy access handle for portability
- Corrosion-resistant, reinforced thermoplastic construction
- Bottom suction design filters debris and removes water down to 1/4" from surface
- Built-in automatic thermal overload protector motor
- 3/4" NPT discharge, 1-1/4" adapter included
- Top discharge design
- 10' power cord



Model No.	Motor HP	Max. Flow Rate	Amps
DC650	1/6	1750 GPH	3.2
DC651	1/3	2160 GPH	4

AUTOMATIC SUBMERSIBLE UTILITY PUMP

- Motor: 1/3 HP
- Max. Flow Rate: 2160 GPH
- Voltage: 115 V
- Amps: 4 A
- Automatically turns on when 1-1/2" of water is detected; turns off when water level falls below 1/4"
- Corrosion-resistant, reinforced thermo plastic construction
- Bottom suction design filters debris and removes water down to 1/4" from surface
- Permanent split capacitor motor and built-in automatic thermal overload protector
- 1" NPT discharge, 3/4" adapter included
- 10' power cord

Model No. DC652



AUTOMATIC POOL COVER PUMP

- Motor: 1/4 HP
- Max. Flow Rate: 2310 GPH
- Voltage: 115 V
- Suction Head: 20'
- Automatically turns on when 2" of water is detected
- Corrosion-resistant, reinforced thermoplastic construction
- Bottom suction design filters debris and removes water down to 1/4"
- Built-in automatic thermal overload protector
- 25' power cord
- 3/4" NPT check valve adapter included

Model No. DC654



BATTERY PUMP

- Max. Flow Rate: 200 GPH
- Air Inlet: 3/4" NPT
- Battery operated, no electrical cords
- Up to 5 hours of continuous use on 3 alkaline D-cell batteries
- Includes an adapter to use with garden hose
- Lifts water to a height of 40'
- Can be used as a siphon

Model No. DC656



PORTABLE TRANSFER PUMP

- Motor: 1/10 HP
- Max. Flow Rate: 264 GPH
- Voltage: 115 V
- Suction Head: 46'



- Built-in automatic thermal overload protection
- Convenient carrying handle for easy transport
- 3/4" NPT discharge
- Garden hose included
- 6' power cord
- Water suction attachment included

Model No. DC655

PLASTIC COLUMN & CAST IRON BASE PUMP

- Max. Flow Rate: 3270 GPH
- Air Inlet: 1-1/4" NPT
- Polypropylene base
- Corrosion-resistant vinyl column and drive shaft
- Fully adjustable automatic vertical float switch
- Top suction screened design prevents clogging
- 1-1/4" discharge
- 1-1/2" adapter included
- 8' power cord

Model No. DC657



WATER PUMPS

SUBMERSIBLE SUMP PUMP

- Motor: 1/3 HP
- Max. Flow Rate: 2530 GPH
- Voltage: 115 V
- Amps: 4.6 A
- Corrosion-resistant, reinforced thermoplastic construction
- Built-in automatic thermal overload protector
- Oil-filled split capacitor motor
- Adjustable tethered, vertical or piggy back float switch
- Top suction screened design prevents clogs
- 10' power cord
- 1-1/2" NPT discharge
- 1-1/4" adapter included

Model No. **DC658**



STAINLESS STEEL HOUSING-CAST IRON BASE SUMP PUMP

- Voltage: 115 V
- Stainless steel motor shell with durable cast iron volute
- Oil-filled permanent split capacitor motor
- Built-in automatic thermal overload protector
- Works with vertical or piggy back float switch for automatic operation
- 1-1/2" discharge
- Sturdy base prevents clogs and prevents pump from moving around in the pit
- 8' power cord

Model No.	Motor HP	Max. Flow Rate	Amps
DC659	1/3	3630 GPH	4.5
DC660	1/2	4400 GPH	5



CAST IRON SEWAGE PUMP

- Motor: 1/2 HP
- Max. Flow Rate: 3880 GPH
- Voltage: 115 V
- Amps: 6.5 A
- Max. Diameter of Waste: 2"
- Durable cast iron construction
- Heavy duty cast iron volute and impeller
- Built-in automatic thermal overload protector motor
- Adjustable tethered or piggy back float switch for automatic operation
- 2" NPT discharge
- 10' power cord

Model No. **DC661**



DUAL VOLTAGE CAST IRON SHALLOW WELL JET PUMP

- Motor: 1/2 HP
- Max. Flow Rate: 710 GPH
- Voltage: 115/ 230 V
- Suction Head: 25'
- For use with shallow well within 25ft
- Durable cast iron pump body
- Built-in automatic thermal overload protection
- Pressure switch pre-set at 30-50 PSI
- 1-1/4" NPT suction and 1" NPT discharge

Model No. **DC662**



DUAL VOLTAGE CAST IRON CONVERTIBLE JET PUMP

- Motor: 1 HP
- Max. Flow Rate: 920 GPH
- Voltage: 115/ 230 V
- Suction Head: 198'
- For use on shallow well applications up to 25ft water level
- For use on deep well applications up to 25-80 feet
- Durable cast iron pump body
- Built-in automatic thermal overload protection
- Ejector is included for deep well usage
- 1-1/4" NPT suction and 1" NPT discharge

Model No. **DC664**





PACKAGING TOOLS

Utility Knives	154 - 155
Packing List Envelopes	156
Poly Bags	156
Tape Guns & Tape	157 - 158
Sealers	159
Stretch Wrap Dispenser	159
Carton Sizer	159
Bag Sealer	159
Steel Strapping	161
Steel Strapping & Tools	161-163
Steel Strapping Dispensers	161
Plastic Strapping	164
Plastic Strapping Tools	164 - 165
Plastic Strapping Dispensers	164
Glue Guns	166
Cable Ties	166
Staple Guns	167
Hammer Tackers	167

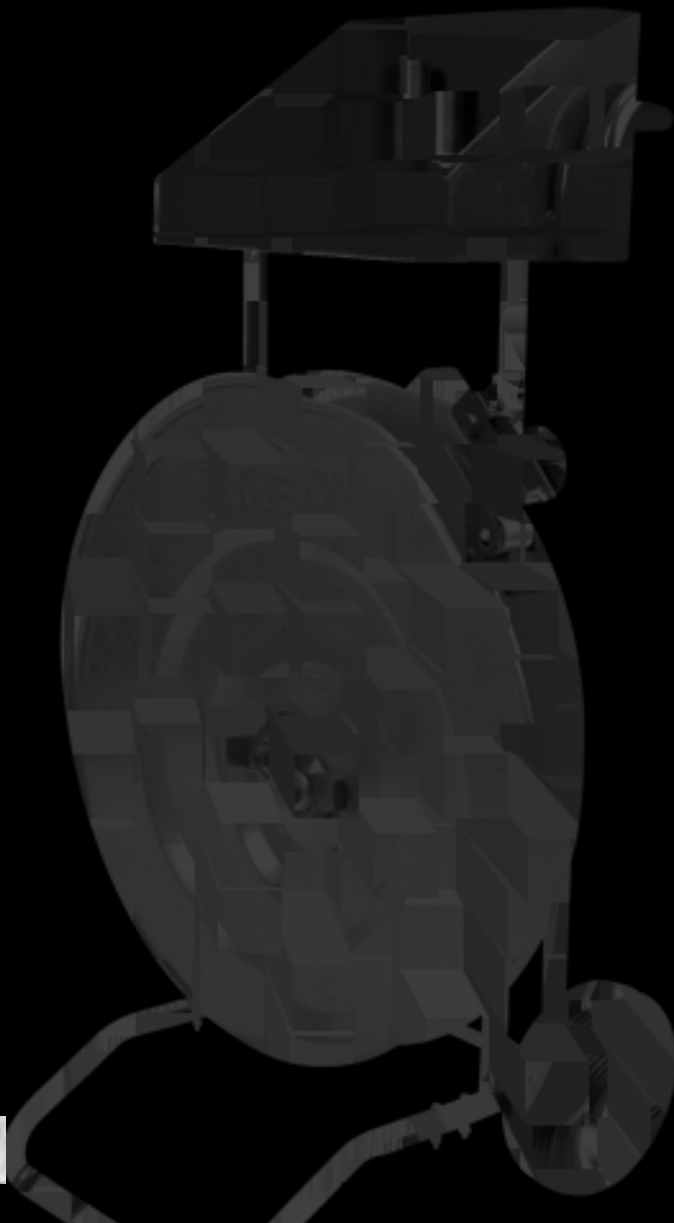

UTILITY KNIVES

HEAVY-DUTY UTILITY KNIFE ATK100

- Auto-reload blade change
- Auto-lock blade
- Thumb operated screw-lock for heavy-duty operation
- Rubber handle insert for superior grip
- Snap-off blades
- Attached blade snapper
- Includes 4 heavy-duty blades
- Use 18 mm blade

Model No. **PE812**



PROFESSIONAL UTILITY KNIFE ATK300

- Auto-lock blade
- Snap-off blades
- Attached blade snapper
- Use 18 mm blade

Model No. **PE814**



PROFESSIONAL UTILITY KNIFE ATK400

- Blade screw lock
- Snap-off blades
- Comes with blade snapper
- Use 18 mm blade

Model No. **PE813**



STANDARD-DUTY UTILITY KNIFE ATK600

- Snap-off blades
- Attached blade snapper
- Includes one extra blade
- Use 9 mm blade

Model No. **PE345**



STANDARD-DUTY UTILITY KNIFE ATK700

- Auto-lock blade
- Durable ABS plastic body
- Snap-off blades
- Attached blade snapper
- Lightweight design
- Use 18 mm blade

Model No. **PE549**



UTILITY KNIVES



STAINLESS STEEL UTILITY KNIFE ATK500

- Auto-lock blade
- Snap-off blades
- Attached blade snapper
- Built-in belt clip
- Uses 9 mm blade

Model No. **PE815**



HEAVY-DUTY UTILITY KNIFE ATK800

- Blade Dimensions: 25 mm x 139 mm
- Blade Thickness: 0.7 mm
- Locking Mechanism: Screw
- Ergonomic handle for superior grip
- Snap-off blades
- Uses 25 mm blade

Model No. **PF710**



HEAVY-DUTY UTILITY KNIFE ATK900

- Blade Dimensions: 18 mm x 139 mm
- Blade Thickness: 0.7 mm
- Locking Mechanism: Screw
- Ergonomic handle for superior grip
- Snap-off blades
- Uses 25 mm blade

Model No. **PF711**



SELF-RETRACTING UTILITY KNIFE ATK1000

- Self-retracting blade for heightened safety
- Durable ABS plastic body
- Lightweight design

Model No. **PF708**

Model No. **PF709** - Replacement Blades

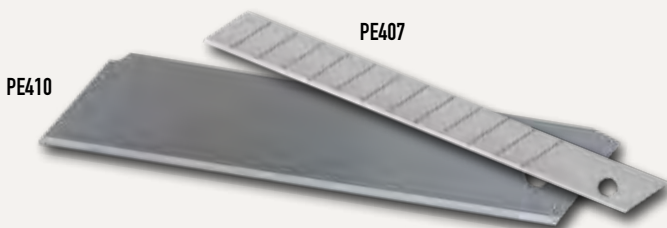

UTILITY KNIFE BLADES

Model No.	Blade Size	Thickness	Qty /Pack
PE407	9 mm	0.4 mm	10
PF205	18 mm	0.5 mm	10
PE410	25 mm	0.7 mm	10

PACKAGING ACCESSORIES

PACKING LIST ENVELOPES

- Ideal for packing slips, invoices, spec sheets, warranties, instructions, etc.
- Backloading
- 1000/case

Model No.	Outside Dimensions	Inside Dimensions	Description
	L" x W"	L" x W"	
PF878	4-1/2 x 5-1/2	4 x 5	Packing List Enclosed/Bilingual
PF879	4-1/2 x 5-1/2	4 x 5	Blank
PF880	4-1/2 x 5-1/2	4 x 5	Packing List Enclosed
PF881	7 x 5-1/2	6-1/2 x 5	Blank
PF882	7 x 5-1/2	6-1/2 x 5	Packing List Enclosed/Bilingual
PF883	10 x 5-1/2	9-1/2 x 5	Blank



RECLOSABLE POLY BAGS

- Hang-holes allow users to hang on hooks or pegs
- Zippered opening allows for easy opening and resealing
- 2-mil thickness
- 100/pack

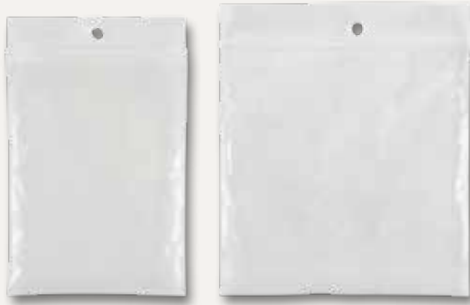

Model No.	Dimensions L" x W"
PF915	3 x 4
PF919	3 x 5
PF922	4 x 4
PF925	4 x 6
PF928	4 x 8
PF929	5 x 7
PF932	5 x 8
PF935	6 x 6
PF937	6 x 8
PF942	6 x 9
PF946	8 x 10
PF949	9 x 6
PF950	9 x 12
PF954	10 x 12
PF957	10 x 13
PF958	12 x 12
PF961	12 x 15
PF965	15 x 20

WHITE BLOCK RECLOSABLE POLY BAGS

- Hang-holes allow users to hang on hooks or pegs
- Identify contents by writing on the white block area
- Zippered opening allows for easy opening and resealing
- 2-mil thickness
- 100/pack

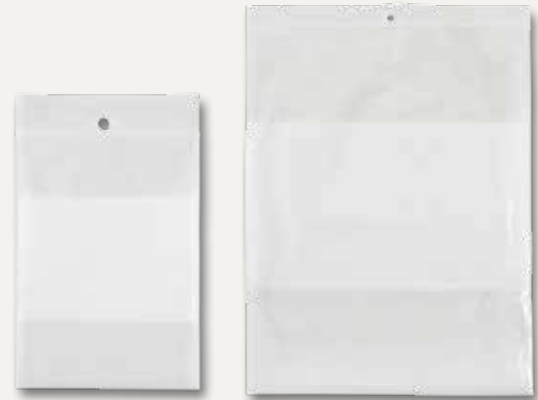

Model No.	Dimensions L" x W"
PF916	3 x 4
PF918	3 x 5
PF926	4 x 6
PF933	5 x 8
PF941	6 x 9
PF948	8 x 10
PF951	9 x 12
PF963	12 x 15

Tape Selection Guide

What's the best tape for your application . . . hot melt or acrylic? When sealing a package, it's important to choose the right kind of carton sealing tape to ensure the box stays securely closed during shipping and/or storage. The following is a comparison of two popular types of carton sealing tape.

Criteria	Hot Melt Tape	Acrylic Tape
Features	Overall superior holding power and tensile strength Quick tack, adheres with minimal pressure and contact time	Good for use in extreme temperatures Strong resistance to oxidation, will not yellow over time
Best Uses	Shipping and short term storage Sealing cartons made of recycled cardboard	Long-term storage Humid and dusty environments

HOT MELT BOX SEALING TAPE

- Possesses superior holding power and tensile strength
- Ideal for use with boxes containing high amounts of recycled content
- Suitable for shipping and short-term storage
- Colour: Clear

Model No.	Width	Length	Thickness
PG127	48 mm (2")	66 m (216')	1.6 mils
PG128	48 mm (2")	100 m (328')	1.6 mils
PG129	48 mm (2")	100 m (328')	2 mils
PG130	72 mm (3")	66 m (216')	1.6 mils
PG131	48 mm (2")	132 m (432')	1.6 mils



ACRYLIC BOX SEALING TAPE

- Elongation at break: 1.3
- Quality acrylic adhesive tape provides consistent performance
- Designed to resist center seam splitting
- Fits on most industrial tape guns
- Colour: Clear

Model No.	Width	Length	Thickness
PF231	48 mm (2")	66 m (216')	1.6 mils
PF232	48 mm (2")	100 m (328')	1.6 mils
PF233	48 mm (2")	100 m (328')	2 mils
PF234	72 mm (3")	66 m (216')	1.6 mils
PF235	48 mm (2")	132 m (432')	1.6 mils



TAPE DISPENSERS & UTILITY TAPES

TAPE DISPENSERS

- Industrial quality tape guns constructed of steel and high impact plastic frame
- Adjustable brake lets you choose the desired release tension



Model No.	Description	Blade
PE321	2" Standard-Duty Plastic	Retractable
PE322	2" Heavy-Duty Steel	Retractable
PE323	3" Heavy-Duty Steel	Retractable
PF712	2" Standard-Duty Plastic	Non-retractable
PF713	2" Heavy-Duty Steel	Non-retractable
PF714	3" Heavy-Duty Steel	Non-retractable



PE321

Retractable safety blade
protects operator from injury



PF713

Non-Retractable
blade with safety cap

MANUAL KRAFT TAPE DISPENSER

- A single pull of the handle moistens and dispenses the required length of gummed tape
- Manual lever dispenses and cuts tape up to 44" long
- Weight: 20.46 lbs.

Model No. **PG200**

* Tape sold separately



REINFORCED KRAFT TAPE

- Water activated adhesive bonds to the carton even in dusty or dirty conditions
- Recommended for use on lightweight cartons of up to 20 lbs.
- Reinforced with fiberglass, adding strength to the tape
- Width: 75 mm (3")
- Length: 150 m (492')
- Colour: Kraft



Model No. **PG132**

UTILITY GRADE DUCT TAPE

- Ideal for a wide variety of projects and applications
- Water resistant
- Easy to tear
- Colour: Silver



Model No.	Width	Length	Thickness
PF688	50 mm (2")	55 m (180')	9 mils
PF689	50 mm (2")	45 m (150')	6 mils

PACKAGING TOOLS

PF464



HEAT IMPULSE SEALERS

- Used for sealing polyethylene, polypropylene, and PVC bags
- Compact design
- Lightweight
- Easy to operate
- 110 V

Model No.	Size"	Power	Replacement Silicon Strip	Replacement PTFE Strip
PF464	8	260 W	PF467	PF468
PF465	12	380 W	PF470	PF471

BAG SEALER

- Heavy-duty bag sealer with tape cutter
- Easy to use: simply twist bag shut and move through slot
- Fits tape width: 3/8"

Model No. PE356

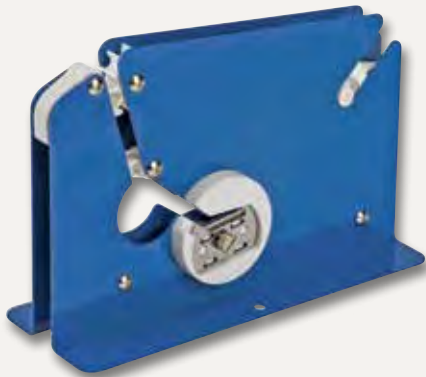

REPLACEMENT PARTS

Model No. PE383, Replacement Blade

CARTON SIZER

- Ideal for cutting boxes down to the desired depth
- Lowers cost on shipping and packaging fill materials
- 12" ruler allows for precise measuring

Model No. PF345



REPLACEMENT PARTS

Model No. PF346, Replacement Blade

FILAMENT TAPE DISPENSERS

- Hand filament tape dispenser
- For up to 1" wide rolls
- Metal construction

Model No. PE355



PE355

STRETCH WRAP DISPENSER

- Needle bearings at the top and bottom of the unit increase tension control
- Tension control knob on top ensures a tight, smooth wrap
- Tension knob also provides a second hand grip for added stability
- Top plate is constructed of cast aluminum for added durability
- Adjusts to hold rolls from 11" to 18" wide

Model No. PE354



PE354



KLETON

STEEL STRAPPING & TOOLS

STEEL STRAPPING

- Strongest material for a wide range of strapping requirements
- Ideal for heavy shipments that require stronger protection over polypropylene and polyester
- Black painted and waxed finish
- Oscillated wound



Model No.	Strap Width" x Thickness"	Core Dimensions"	Strength lbs.	Feet /Coil
PG001	3/8 x 0.015	16 x 3	680	5310
PG002	3/8 x 0.020	16 x 3	900	3800
PG003	1/2 x 0.015	16 x 3	910	3550
PF404	1/2 x 0.020	16 x 3	1200	2940
PG004	1/2 x 0.023	16 x 3	1380	2370
PG005	5/8 x 0.015	16 x 3	1125	2820
PF405	5/8 x 0.020	16 x 3	1500	2360
PG006	5/8 x 0.023	16 x 3	1725	1890
PG007	3/4 x 0.015	16 x 3	1360	2385
PF406	3/4 x 0.020	16 x 3	1800	1960
PG008	3/4 x 0.023	16 x 3	2070	1580
PF407*	1-1/4 x 0.031	16 x 1-1/4	5500	760

* Ribbon wound

STEEL & PLASTIC STRAPPING DISPENSER

- Strapping cart is designed to be compatible with polyester, polypropylene and steel strapping
- The unique multi-tier discs accommodate three core strapping sizes: 8" x 8", 16" x 3" and 16" x 6"
- Rubber rollers prevent strapping from unrolling
- Cart includes large storage tray for strapping accessories
- Heavy-duty 8" rubber wheels for easy maneuverability
- For use with 1/2" - 3/4" strapping

PE555



Model No. PE555

[FIND OUT HOW IT WORKS](https://www.youtube.com/KletonInd)
www.youtube.com/KletonInd

For details and "HOW TO" on this and other KLETON products please visit us at:
www.youtube.com/user/KletonInd

STEEL SEALS

- All fully galvanized steel
- Open (snap-on) type: Used on flat and smooth surfaces
- Fully closed (push) type: Used on curved and irregular surfaces

Model No.	Strap Width"	Qty /Box
PF408	1/2	2000
PF409	5/8	2000
PF410	3/4	2000
PF411	1/2	5000
PF412	5/8	5000
PF413	3/4	5000
PF414	1-1/4	1000

OPEN (SNAP-ON)

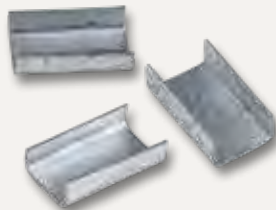

Model No.	Strap Width"	Qty /Box
PF415	1/2	2000
PF416	5/8	2000
PF417	3/4	2000
PF418	1/2	5000
PF419	5/8	5000
PF420	3/4	5000
PF421	1-1/4	1000

FULLY CLOSED (PUSH)



STEEL STRAPPING SEALERS FOR USE WITH OPEN SEALS

- Double notch creates a strong interlocking joint
- Heat-treated steel construction for added durability
- Ball handles provide a superior grip
- Ideal for use with feed-wheel tensioners

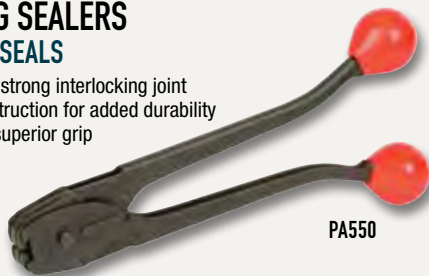

PA550

Model No.	Strap Width"	Strap Thickness"
PA550	1/2	0.018 - 0.023
PA562	5/8	0.018 - 0.023
PA551	3/4	0.018 - 0.027

STEEL STRAPPING SEALERS FOR USE WITH CLOSED AND SEMI-CLOSED SEALS

- Single notch for use with closed and semi-closed seals
- Chrome-plated steel construction
- Ball handles provide a superior grip
- Ideal for use with push-bar style tensioners



PE351

Model No.	Strap Width"	Strap Thickness"
PE351	1/2	0.018 x 0.023
PE352	5/8	0.018 x 0.023
PE353	3/4	0.018 x 0.027

STEEL STRAPPING TOOLS

HEAVY-DUTY STEEL STRAPPING SEALERS

- Single notch
- Heat-treated steel construction for added durability
- Ideal for use with push-bar style tensioners
- For use with 1 1/4" wide steel strapping
- Accepts steel strapping between 0.025" to 0.035" in thickness

Model No. **PB016** For use with closed and semi-closed seals

Model No. **PF687** - For use with open seals



PB016



PF687

STEEL STRAPPING TENSIONERS PUSH BAR STYLE

- Accepts steel strapping up to 0.020" thick
- Light tension
- Limited take-up
- Ideal for applications on small, round or irregular surfaces
- For use with push type seals

PA567



PE350



Model No.	Description	Strap Width"
PA567	Standard	3/8 - 1/2
PE350	Heavy-Duty	3/8 - 3/4

STEEL STRAPPING TENSIONERS FEED-WHEEL STYLE

- Accepts steel strapping up to 0.035" thick
- Fast and easy operation
- Medium/heavy tension
- Unlimited take-up
- Ideal for applications on flat surfaces
- For use with open seals

Model No.	Description	Strap Width"
PC938	Standard	3/8 - 3/4
PC399	Heavy-Duty	3/4 - 1-1/4



PC938

STEEL STRAPPING TOOLS

STANDARD-DUTY SAFETY CUTTERS FOR STEEL STRAPPING

- Cuts steel strapping 3/8" - 1 1/4" wide x 0.036" thick
- Safety design holds strapping in place to prevent injuries from flying ends
- Rubber pads gently release strapping when being cut

Model No. **PC446**



HEAVY-DUTY SAFETY CUTTERS FOR STEEL STRAPPING

- Cuts steel strapping 3/8" - 2" wide x 0.050" thick
- Powerful drop-forged steel design
- Heavy-duty performance for industrial applications
- 24" long

Model No. **PC479**



MANUAL SEALLESS STEEL STRAPPING TOOL

- Multi purpose tool cuts, tightens and seals for optimal working efficiency
- Keeps straps secure with punch joint sealing
- Made to withstand high volume usage
- Fits strap width: 1/2" - 3/4"
- Fits strap thickness: 0.015" - 0.027"
- Type: Push Bar

Model No. **PF705**



1/2" STEEL STRAPPING KIT EASY-TO-USE, EFFICIENT SYSTEM

Contains closed seals for irregularly shaped surfaces
Consists of the following components:

- 1- **PF404** 1/2" x 0.020" steel strapping
- 1- **PC446** cutter 3/8" to 1-1/4"
- 1- **PA567** push bar tensioner 3/8" to 1/2"
- 1- **PE351** 1/2" wide sealer for closed seals
- 1- **PF415** 1/2" wide closed seals 2000/box
- 1- **PE555** dispenser

Model No. **PB655**



1/2" STEEL STRAPPING KIT EASY-TO-USE, EFFICIENT SYSTEM

Contains open seals for flat surfaces
Consists of the following components:

- 1- **PF404** 1/2" x 0.020" steel strapping
- 1- **PC446** cutter 3/8" to 1-1/4"
- 1- **PC938** 3/8" to 3/4" wide standard tensioner
- 1- **PA550** 1/2" wide sealer for open seals
- 1- **PF408** 1/2" wide open seals 2000/box
- 1- **PE555** dispenser

Model No. **PB654**



PLASTIC STRAPPING & DISPENSERS

EVERYTHING YOU NEED TO GET YOUR SHIPMENTS PACKAGED QUICKLY AND SAFELY

POLYPROPYLENE STRAPPING

- Ideal for light-duty palletizing and bundling
- Lightweight, easy-to-use and recyclable

Model No.	Strap Width"	Strap Thickness"	Feet /Coil	Core Size"	Strength lbs.	Colour	Grade
PF983	3/8	0.024	12,900	8 x 8	300	White	Machine
PF984	1/2	0.023	9,900	8 x 8	300	White	Machine
PF985	1/2	0.035	5,600	16 x 6	750	Black	Manual
PF986	1/2	0.032	7,200	16 x 6	600	Black	Manual
PF987	1/2	0.032	7,200	8 x 8	600	Black	Manual
PF988	5/8	0.030	6,000	8 x 8	700	Black	Manual

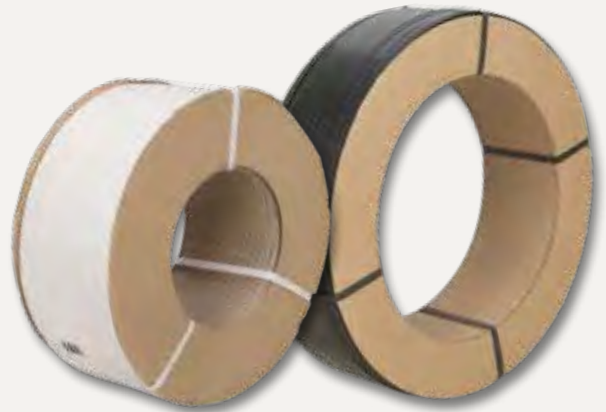

POLYESTER STRAPPING

- Ideal for medium to heavy-duty palletizing
- Moisture-resistant, safe to handle and recyclable
- Approved by the Association of American Railroads (AAR)
- 4000' coil
- 5/8" strap width
- 16" x 6" core size
- 1400 lbs. strength
- Manual grade
- 0.035" strap thickness

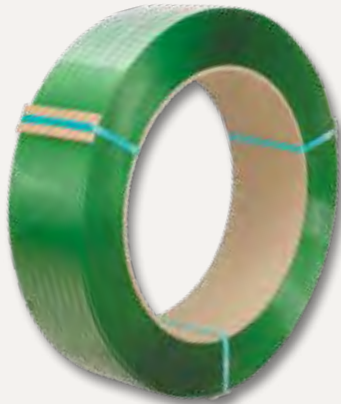

Model No. **PG175**

SERRATED STRAPPING SEALS

- Serrated seals for use with polyester strapping
- Fits 5/8" strap width
- Qty/Box: 1000



Model No. **PF991**

STEEL SEALS

- All fully galvanized steel
- Open (snap-on) type: Used on flat and smooth surfaces
- Fully closed (push) type: Used on curved and irregular surfaces



OPEN (SNAP-ON)

Model No.	Strap Width"	Qty /Box
PF408	1/2	2000
PF409	5/8	2000
PF410	3/4	2000
PF411	1/2	5000
PF412	5/8	5000
PF413	3/4	5000
PF414	1-1/4	1000

FULLY CLOSED (PUSH)

Model No.	Strap Width"	Qty /Box
PF415	1/2	2000
PF416	5/8	2000
PF417	3/4	2000
PF418	1/2	5000
PF419	5/8	5000
PF420	3/4	5000
PF421	1-1/4	1000

POLYPROPYLENE & POLYESTER STRAPPING DISPENSER

- Cart includes large storage tray for strapping accessories
- For use with 1/2" - 3/4" strapping
- Heavy-duty 8" rubber wheels for easy maneuverability
- Accommodates core inside diameter of 8"

Model No. **PF807**



STEEL & PLASTIC STRAPPING DISPENSER

- Strapping cart is designed to be compatible with polyester, polypropylene and steel strapping
- The unique multi-tier discs accommodate three core strapping sizes: 8" x 8", 16" x 3" and 16" x 6"
- Rubber rollers prevent strapping from unrolling
- Cart includes large storage tray for strapping accessories
- Heavy-duty 8" rubber wheels for easy maneuverability
- For use with 1/2" - 3/4" strapping

Model No. **PE555**



POLYPROPYLENE & POLYESTER STRAPPING TENSIONERS

- Accepts strapping 3/8 - 3/4" wide and up to 0.035" in thickness
- Superior design and performance
- Premium copper bushings
- Built-in strapping cutter
- Ideal for applications on flat surfaces
- For use with open seals or buckles

Model No. **PC939**



POLYESTER STRAPPING TENSIONER

- Accepts strapping 3/8 - 3/4" wide and up to 0.039" in thickness
- Tightens strapping quickly with little effort
- Built-in strapping cutter
- Ideal for applications on flat surfaces
- Compatible with polyester strapping

Model No. **PF993**



POLYPROPYLENE STRAPPING SEALERS

- Heat-treated steel construction for superior strength and durability
- Prevents strapping from loosening during transit
- Long 18" handle requires less effort
- Use on open steel seals



PA555

POLYESTER STRAPPING SEALER

- Heat-treated steel construction for superior strength and durability
- Prevents strapping from loosening during transit
- Long 18" handle requires less effort
- Offset jaws are longer on one side for better grip
- Specially designed for use with serrated seals
- Fits strap 5/8" strap width

Model No. **PF992**



Model No.	Strap Width"	Strap Thickness"
PA555	1/2	≤ 0.027
PA556	5/8	0.023 - 0.039
PF459	3/4	≤ 0.027

5/8" POLYESTER STRAPPING KIT EASY-TO-USE, EFFICIENT SYSTEM

Consists of the following components:

- 1- PE555 Dispenser,
- 1- PG175 5/8" x 4000' x 1400 lbs strength polyester strapping,
- 1- PF991 5/8" open seals, 1000/box,
- 1- PF992 5/8" polyester sealer,
- 1- PF993 polyester strapping tensioner

Model No. **PG187**

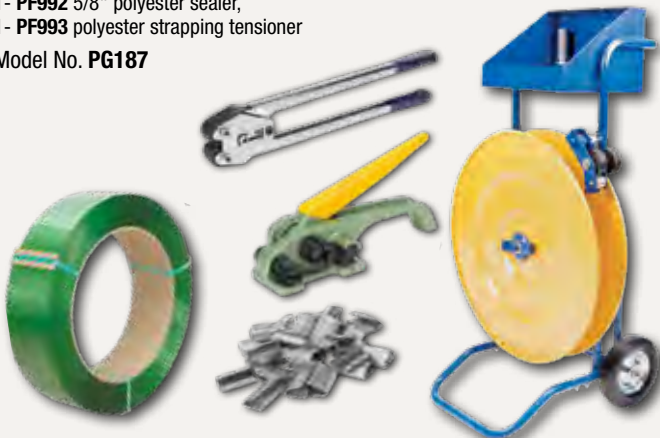

1/2" POLYPROPYLENE STRAPPING KIT EASY-TO-USE, EFFICIENT SYSTEM

Consists of the following components:

- 1- PF985 1/2" X 5600' 750 lb strength polypropylene strapping
- 1- PE555 dispenser
- 1- PA555 1/2" poly sealer
- 1- PC939 polypropylene and polyester tensioner
- 1- PF408 1/2" open seals, 2000/box

Model No. **PD023**



GLUE GUNS & CABLE TIES

PROFESSIONAL GLUE GUNS

- Perfect for light-duty carton sealing or small manufacturing projects
- Accepts 7/16" diameter regular glue sticks
- Trigger design for better grip control
- Features precise, even adhesive distribution
- 120 V / 80 W heater
- Comes with metal wire stand

Model No. **PE339**



PE339

HEAVY-DUTY GLUE GUNS

- Ideal for medium-heavy duty applications
- Accepts 7/16" diameter regular glue sticks
- Ergonomic trigger design for better grip and comfort
- Features precise, even adhesive distribution
- Illuminated on/off switch
- 120 V / 100 W heater
- Comes with metal wire stand

Model No. **PE340**



PE340

GLUE STICKS

Model No.	Glue Type	Viscosity Centipoise	Melting Point		Typical Applications	Dim."	Qty /Case
			°C	°F			
PE341	Clear	11000-13000	77-82	170-180	High strength, high temp, for non-porous materials such as metal and plastics	7/16 x 4	2000
PE342	Clear	11000-13000	77-82	170-180	High strength, high temp, for non-porous materials such as metal and plastics	7/16 x 10	803
PE343	Amber	5000	95	203	For porous materials such as corrugated boxes or wood	7/16 x 15	536
PE541	Clear	9400	80	176	All temp. all purpose for porous and non-porous materials	7/16 x 10	803

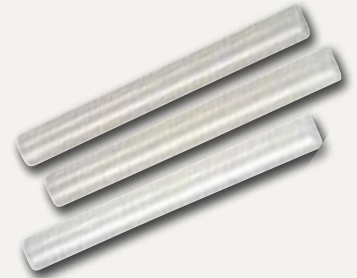

aurora tools®



CABLE TIE SETS

Model No. **PF397**

Set Includes: 400 x PF387, 400 x PF389, 200 x PF391

Model No. **PF398**

Set Includes: 50 x PF393, 50 x PF395

CABLE TIES

- Manufactured from Dupont™ Zytel®101F and Ascend™ Vydyn® 21SPF
- Ideal use in temperatures ranging from -20°C to 80°C
- **PF396** has the added benefit of weather resistance

Model No.	Style	Length"	Bundle Dia. Min." - Max."	Tensile Strength lb	Qty /Bag
PF385	Natural	4	1/16 - 7/8	18	1000
PF386	Black	4	1/16 - 7/8	18	1000
PF387	Natural	6	1/16 - 1-1/4	40	1000
PF388	Black	6	1/16 - 1-1/4	40	1000
PF389	Natural	8	1/16 - 1-3/4	50	1000
PF390	Black	8	1/16 - 1-3/4	50	1000
PF391	Natural	11	1/16 - 3	50	1000
PF392	Black	11	1/16 - 3	50	1000
PF393	Natural	15	1/16 - 4	120	100
PF394	Black	15	1/16 - 4	120	100
PF395	Natural	24	3/16 - 7	175	100
PF396	Black	24	3/16 - 7	175	100

STAPLE GUNS

HEAVY-DUTY STAPLE GUNS

- All-steel construction, with rubberized handle for superior grip
- Easy squeeze, double leverage handle reduces operators fatigue
- Hand-contoured handle features molded plastic handle stop
- Bottom loading, with jam proof mechanism
- Adjustable driving force facilitates use
- Accepts staples in 3 lengths: 5/16", 3/8" and 1/2", with a crown width of 3/8"

Model No. **PE337**



HEAVY-DUTY HAMMER TACKERS

- All-steel construction, with rubberized handle for superior grip
- Precision locked rear loading, with jam proof mechanism
- Retractable striking edge
- Chrome plated finish
- Accepts staples in 3 lengths: 5/16", 3/8" and 1/2", with a crown width of 3/8"

Model No. **PE338**



STAPLES

Model No.	Size"	Qty /box
ON919	5/16	5000
ON920	3/8	5000
ON921	1/2	5000



INDEX

A		G		S	
Appliance Trucks	25	Gas Cylinder Cabinets.....	127	Safety Guards.....	131-133
Acrylic Tape	157	Gas Cylinder Carts.....	21	Sawhorses	56
B		Glue Guns.....	166	Security Trucks.....	32
Bag Sealer.....	159	Glue Sticks	166	Semi Live Skids.....	47
Bar Cradle Carts	54	Guard Rails.....	132-134	Semi-Pneumatic Wheel.....	61
Bar Storage Racks.....	125	Guard Rail Post.....	134	Service Trucks	38-39
Basket Wire Shelving.....	104	H		Sheet Racks	126
Benches	88	Hammer Tackers.....	167	Shelf Trucks.....	33-40
Bins.....	116-122	Hand Trucks.....	18-25	Shop Desks	88
Bollards.....	133	Hardwood Dollies.....	51	Siphon Pumps	148
Boltless Shelving	108	Heat Impulse Sealers.....	159	Skids.....	47
Box Sealing Tape	157	Hi-Stak Plastic Storage Bins	116	Slanted Wire Shelving.....	104
Box Truck	27-29	Hoists.....	15-16	Snap Hooks	13
Bulk Stacking Container.....	123	Hydraulic Pallet Trucks.....	8-11	Specialized Dollies.....	52-56
Bung Nut Wrenches.....	145	Hydraulic Platform Lift Stacker.....	13	Spool Cart.....	57
C		I - L		Stacking Racks.....	124
Cabinet Workbenches	82	Ice Chock	63	Steel Dollies.....	52
Cable Reel Rollers.....	124	Institutional Platform Trucks.....	48	Step Ladders	91-93
Cable Ties.....	166	Jumbo Plastic Bins	117	Step Stands.....	90
Can Tipper.....	141	Kraft Tape	158	Step Stools	86
Carousel Drawer Cabinets	109	Ladders.....	91-93	Steel Seals	161, 164
Carton Racks.....	126	Lever Hoists.....	16	Steel Strapping.....	161
Carton Sizer.....	159	Lift Tables.....	4-7	Stock Picking Trucks.....	37
Casters.....	58-61	Lockers.....	96-97	Storage Bins & Racks.....	120-122, 125-126
Chairs.....	85	Locker Room Benches.....	88	Storage Cabinets	114-115
Chair Caddy.....	85	Louvered Racks.....	120-122	Staple Guns.....	167
Chain Hoists.....	15	Low Profile Shelf Trucks.....	36	Staples.....	167
Collapsible Containers	119	Lumber Carts.....	55-56	Strapping Dispenser	161, 165
Cone Cart	19	M - O		Strapping Kits.....	163, 165
Cork Boards.....	86	Machine Stands.....	83	Strapping Sealers	161, 165
Corner Bumpers	63	Mail Cart.....	105	Strapping Seals	161
Cradle Truck	53	Maintenance Platforms.....	94	Strapping Tensioners	162, 165
D		Maxi-Bench Workstations	81	Stretch Wrap Dispenser	159
Dead Skids	47	Mesh Stock Trucks	20-31	Strip Curtains.....	135
Dock Bumpers.....	63	Mobile Service Trucks.....	38	T	
Dollies	51-56	Mobile Workbenches	80-81	Tape.....	157-159
Drawer Cabinets.....	109, 118	Nylon Casters	59, 61	Tape Dispensers	158
Dry Erase Markers.....	87	Order Picking Trucks.....	37	Tape Guns.....	158
Drywall Carts.....	55	P		Tarpaulins.....	136-138
Drum Dollies.....	143	Packing List Envelopes	156	Tie Downs	138
Drum Faucets.....	145	Pallet Dolly	53	Tilt Bins	118
Drum Grabbers.....	140	Pallet Lifter	14	Tilt Bin Racks.....	118
Drum Lifting Hook.....	141	Pallet Pullers.....	13	Tilt-N-Roll Step Stands	90
Drum Pumps	146-150	Pallet Trucks	8-11	Tilt-N-Roll Ladders	93
Drum Rockers.....	141	Panel Carts	54, 56-57	Tilt Trucks.....	26
Drum Stacking Racks	140	Parts Cabinets	110-113	Tool Box Benches	81
Drum Trucks	142-143	Pedestal Benches.....	80, 83	Trailer Access Rolling Ladder.....	91
Duct Tape	158	Pipe & Bar Cradle Truck.....	53	Trailer Stabilizing Jack.....	63
Dump Hoppers.....	27	Plastic Storage Bins.....	116-122	Trolleys.....	17, 41
Dump Trucks	26	Plastic Strapping	164	U - W	
E		Platform Lift Stacker.....	13	U-Boat Platform Trucks.....	54
Elevated Platform Trucks	46	Platform Trucks	39-50	Upright Protectors.....	133
Enclosed Wire Stock Picking Carts	105	Plug Wrench	145	Utility Cart	40-41
F		Pneumatic Casters.....	60	Utility Knives.....	154-155
Filament Tape Dispensers.....	159	Poly Bags	156	Wagon Trucks	46
Flatbead Lumber Carts	55	Polyester Strapping.....	164	Water Pumps.....	151-152
Flat-Free Casters.....	61	Polyurethane Casters.....	58	Welding Cart.....	21
Foldable Platform Trucks.....	48	Polyolefin Casters	59	Workhorses	56
Folding Benches	85	Polypropylene Strapping	164	Wheel Chocks.....	62-63
Folding Chairs.....	85	Q		White Boards.....	86-87
Folding Ladders.....	93	Quick Links.....	13	Wide Span Shelving.....	108
Folding Tables.....	84	R		Wire Carts	102
Fork Extensions	12	Racking Protectors	132	Wire Mesh Partitions.....	128-130
Frame Sheet Carts.....	54	Reel Dispensers.....	124	Wire Mesh Shelf Trucks	29-31
Furniture Pads.....	138	Rolling Ladders.....	91-93	Wire Reel Cady	57
		Rubber Casters.....	58, 60	Wire Shelving.....	98-107
				Wire Spool Cart.....	57
				Work Benches	65-83
				Work Bench Tops.....	76
				Work Platforms.....	90